

KENWOOD

ALL MODE MULTI-BANDER

TS-570S

Intelligent Digital Enhanced Communications System

HF TRANSCEIVER

TS-570D

Intelligent Digital Enhanced Communications System

INSTRUCTION MANUAL

KENWOOD CORPORATION

APPLICABLE MODEL

This manual applies to the following model:

TS-570S: All mode multi-bander

TS-570D: HF Transceiver

Intelligent Digital Enhanced Communications System

SUPPLIED ACCESSORIES

Carefully unpack the transceiver. We recommend that you identify the items listed in the table below. In addition, it is safe to keep the box and the packing material. You may need to repack the transceiver in the future.

Accessory	Part Number	Quantity
Microphone	T91-0352-XX	1
DC power cable	E30-3157-XX	1
7-pin DIN plug	E07-0751-XX	1
13-pin DIN plug	E07-1351-XX	1
Fuse (25 A)	F05-2531-XX	1
Fuse (4 A)	F06-4027-XX	1
Instruction manual	B62-0623-XX	1
Schematic/block diagrams ¹ (U.S.A. and Canada only)	—	1
Warranty card (U.S.A., Canada, and Europe only)	—	1

¹ For other markets, schematic and block diagrams are available as options.

This transceiver is equipped with a bail on the bottom so that you can angle the transceiver. Pull the bail forward to the limit as shown:

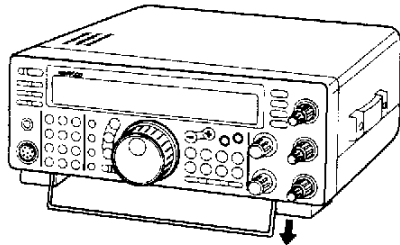

NOTICE TO THE USER

One or more of the following statements may be applicable to this equipment.

FCC WARNING

This equipment generates or uses radio frequency energy. Changes or modifications to this equipment may cause harmful interference unless the modifications are expressly approved in the instruction manual. The user could lose the authority to operate this equipment if an unauthorized change or modification is made.

INFORMATION TO THE DIGITAL DEVICE USER REQUIRED BY THE FCC

This equipment has been tested and found to comply with the limits for a Class B digital device, pursuant to Part 15 of the FCC Rules. These limits are designed to provide reasonable protection against harmful interference in a residential installation.

This equipment generates, uses and can generate radio frequency energy and, if not installed and used in accordance with the instructions, may cause harmful interference to radio communications. However, there is no guarantee that the interference will not occur in a particular installation. If this equipment does cause harmful interference to radio or television reception, which can be determined by turning the equipment off and on, the user is encouraged to try to correct the interference by one or more of the following measures:

- Reorient or relocate the receiving antenna.
- Increase the separation between the equipment and receiver.
- Connect the equipment to an outlet on a circuit different from that to which the receiver is connected.
- Consult the dealer for technical assistance.

THANK YOU

Thank you for choosing the **KENWOOD TS-570** series. This **Intelligent Digital Enhanced Communications System** was developed by a team of engineers determined to continue the tradition of excellence and innovation in **KENWOOD HF** transceivers.

This transceiver includes a 16-bit Digital Signal Processing (DSP) unit to process audio frequencies. By taking maximum advantage of DSP technology the transceiver gives you enhanced interference reduction capabilities and improves the quality of audio that you transmit. You will find the differences when you fight QRM and QRN in the new solar cycle. As you learn how to use this transceiver, you also will find **KENWOOD** is pursuing "user friendliness". For example, each time you change the Menu No. in Menu mode, you will see, on the display, scrolling messages that tell what you are selecting.

Though user friendly, this transceiver is technically sophisticated and some features may be new to you. Consider this manual to be a personal tutorial from the designers. Allow the manual to guide you through the learning process now, then act as a reference in the coming years.

FEATURES

Taking full advantage of DSP technology, this transceiver

- Provides high performance receive filters.
- Enhances the Beat Cancel and Noise Reduction tools.
- Allows total customization of transmitted audio through the use of functions such as the Transmit Equalizer.
- Enables Automatic Zero-beating for CW operation.

To pursue user friendliness, this transceiver

- When in Menu mode, scrolls messages to tell you what you are selecting.
- Allows you to quickly and easily save the current transceiver settings in Quick memory.
- Is equipped with a large, easy to read LCD display.

WRITING CONVENTIONS FOLLOWED

The writing conventions described below have been followed to simplify instructions and avoid unnecessary repetition. This format is less confusing for the reader. Reviewing the following information now will reduce your learning period. That means less time will be spent reading this manual; more time will be available for operating.

Furthermore, a system of advisories is used as follows:

WARNING! ➔ Possibility of personal injury

CAUTION: ➔ Possibility of equipment damage

Note: ➔ Important information or operating tip

Instruction	What to Do
Press [KEY].	Press and release KEY.
Press [KEY1]+[KEY2].	Press and hold KEY1 down, then press KEY2. If there are more than two keys, press and hold down each key in turn until the final key has been pressed.
Press [KEY1], [KEY2].	Press KEY1 momentarily, release KEY1, then press KEY2.
Press [KEY]+ POWER ON.	With the transceiver power OFF, press and hold KEY, then switch ON the transceiver power by pressing the POWER switch.

Note: Basic procedures are numbered sequentially to guide you step-by-step. Additional information pertaining to a step, but not essential to complete the procedure, is provided in bulleted form following many steps.

CONTENTS

PRECAUTIONS	IV
CHAPTER 1 INSTALLATION	1
ANTENNA CONNECTION	1
GROUND CONNECTION	2
LIGHTNING PROTECTION	2
DC POWER SUPPLY CONNECTION	2
REPLACING FUSES	2
ACCESSORY CONNECTIONS	3
FRONT PANEL	3
Headphones (PHONES)	3
Microphone (MIC)	3
REAR PANEL	3
External Speaker (EXT SP)	3
Keys and Keyboards for CW Operation (PADDLE and KEY)	3
CHAPTER 2 YOUR FIRST QSO	4
RECEIVING	4
TRANSMITTING	5
CHAPTER 3 GETTING ACQUAINTED	6
FRONT PANEL	6
MICROPHONE	9
REAR PANEL	10
DISPLAY	11
CHAPTER 4 OPERATING BASICS	13
SWITCHING POWER ON/OFF	13
ADJUSTING VOLUME	13
AUDIO FREQUENCY (AF) GAIN	13
RADIO FREQUENCY (RF) GAIN	13
SELECTING VFO A OR VFO B	13
SELECTING A BAND	13
SELECTING A MODE	14
ADJUSTING SQUELCH	14
SELECTING A FREQUENCY	14
FRONT PANEL METER	14
TRANSMITTING	15
SELECTING TRANSMIT POWER	15
MICROPHONE GAIN	15
CHAPTER 5 MENU SETUP	16
WHAT IS A MENU?	16
MENU A/ MENU B	16
MENU ACCESS	16
MENU CONFIGURATION	17
CROSS REFERENCE FOR MENU FUNCTIONS	19
CHAPTER 6 BASIC COMMUNICATING	20
SSB TRANSMISSION	20
CW TRANSMISSION	21
AUTO ZERO-BEAT	21
TX SIDETONE/ RX PITCH FREQUENCY	21
FM TRANSMISSION	22
TX DEVIATION SELECTION	22
AM TRANSMISSION	22
CHAPTER 7 SPECIALIZED COMMUNICATING	23
SPLIT-FREQUENCY OPERATION	23
TF-SET (TRANSMIT FREQUENCY SET)	23
FM REPEATER OPERATION	24
SELECTING SUBTONE FREQUENCY	25
CONTINUOUS OR BURST SUBTONES?	25
FM CTCSS OPERATION	25
DIGITAL OPERATION	26
RTTY (FREQUENCY SHIFT KEYING)	26
AMTOR/ PACKET/ PACTOR/ G-TOR™/ CLOVER	27
SLOW SCAN TV/ FACSIMILE	28
SATELLITE OPERATION	28
CHAPTER 8 COMMUNICATING AIDS	29
RECEIVING	29
SELECTING YOUR FREQUENCY	29
Direct Frequency Entry	29
Using 1 MHz Steps	29
Quick Changes	29
Fine Tuning	30
Equalizing VFO Frequencies (A=B)	30
RIT (RECEIVE INCREMENTAL TUNING)	30
AGC (AUTOMATIC GAIN CONTROL)	30
TRANSMITTING	31
VOX (VOICE-OPERATED TRANSMIT)	31
Microphone Input Level	31
Delay Time	31
SPEECH PROCESSOR	32
XIT (TRANSMIT INCREMENTAL TUNING)	32
CUSTOMIZING TRANSMIT SIGNAL CHARACTERISTICS	33
Changing Transmit Bandwidth (SSB/AM)	33
Equalizing Transmit Audio (SSB/FM/AM)	33
TRANSMIT INHIBIT	33
CHANGING FREQUENCY WHILE TRANSMITTING	33
CW BREAK-IN	34
USING SEMI BREAK-IN OR FULL BREAK-IN	34
ELECTRONIC KEYS	34
CHANGING KEYING SPEED	34
AUTO WEIGHTING	34
Reversible Auto Weighting	34
BUG KEY FUNCTION	35
CW MESSAGE MEMORY	35
Storing CW Messages	35
Checking CW Messages without Transmitting	35
Transmitting CW Messages	35
CHAPTER 9 REJECTING INTERFERENCE	36
IF FILTER	36
CHANGING IF FILTER BANDWIDTH	36
IF SHIFT	36
NOISE BLANKER	36
ATTENUATOR	37
PREAMPLIFIER	37

DSP TOOLS	37	Equipment Needed	51
CHANGING RECEIVE BANDWIDTH	37	Connections	51
SSB/ FM/ AM Modes	37	COMMUNICATION PARAMETERS	51
CW/ FSK Modes	38	USING A TRANSVERTER	51
BEAT CANCEL	38	AUTOMATIC ANTENNA TUNER.....	52
NOISE REDUCTION	38	PRESETTING	52
Setting NR2 Time Constant	38	DRU-3A DIGITAL RECORDING UNIT	
CHAPTER 10 MEMORY FEATURES	39	(OPTIONAL)	53
MICROPROCESSOR MEMORY BACKUP	39	RECORDING MESSAGES	53
CONVENTIONAL MEMORY	39	MESSAGE PLAYBACK	53
STORING DATA IN MEMORY	39	Checking Messages	53
Simplex Channels	39	Sending Messages	54
Split-Frequency Channels	40	Changing Inter-message Interval	54
MEMORY RECALL AND SCROLL	40	Changing Volume	54
Memory Recall	40	VS-3 VOICE SYNTHESIZER (OPTIONAL)	55
Memory Scroll	41	CHAPTER 13 OPTIONAL ACCESSORIES	56
Temporary Frequency Changes	41	CHAPTER 14 INSTALLING OPTIONS	57
Memory-VFO Split Operation	41	REMOVING THE BOTTOM CASE	57
MEMORY TRANSFER	42	DRU-3A DIGITAL RECORDING UNIT	57
Memory ⇒ VFO Transfer	42	VS-3 VOICE SYNTHESIZER UNIT	58
Channel ⇒ Channel Transfer	42	YK-88C-1/ YK-88CN-1/ YK-88SN-1 FILTERS	58
STORING FREQUENCY RANGES	43	SO-2 TEMPERATURE-COMPENSATED CRYSTAL	
Confirming Start/End Frequencies	43	OSCILLATOR (TCXO)	59
Programmable VFO	43	CHAPTER 15 CONNECTING PERIPHERAL EQUIPMENT	60
ERASING MEMORY CHANNELS	43	COMPUTER	60
Full Reset	43	COMPATIBLE TRANSCEIVER	60
Memory Channel Lockout	44	RTTY EQUIPMENT	61
QUICK MEMORY	44	LINEAR AMPLIFIER	61
STORING INTO QUICK MEMORY	44	ANTENNA TUNER	61
RECALLING QUICK MEMORY	45	MCP AND TNC	62
TEMPORARY FREQUENCY CHANGES	45	CHAPTER 16 MAINTENANCE	63
QUICK MEMORY ⇒ VFO TRANSFER	45	GENERAL INFORMATION	63
CHAPTER 11 SCAN	46	SERVICE	63
PROGRAM SCAN	46	SERVICE NOTE	63
SCAN HOLD	46	CLEANING	63
MEMORY SCAN	47	INTERNAL ADJUSTMENTS	64
ALL-CHANNEL SCAN	47	REFERENCE FREQUENCY CALIBRATION	64
GROUP SCAN	47	ACCESSING THE INTERNAL FUSE	64
CHAPTER 12 OPERATOR CONVENIENCES	48	TROUBLESHOOTING	65
MICROPROCESSOR RESET	48	SPECIFICATIONS	68
INITIAL SETTINGS	48	APPENDIX: COM CONNECTOR PROTOCOL	70
PARTIAL RESET	48	INDEX	82
FULL RESET	48		
SWITCHING ANT 1/ ANT 2	48		
FREQUENCY LOCK FUNCTION	48		
BEEP FUNCTION	49		
DISPLAY DIMMER	49		
PROGRAM FUNCTION BUTTON	49		
QUICK DATA TRANSFER	50		
SETTING UP	50		
Equipment Needed	50		
Connections	50		
USING QUICK TRANSFER	50		
Transferring Data	50		
Receiving Data	50		
COMPUTER CONTROL	51		
SETTING UP	51		

1

2

3

4

5

6

7

8

9

10

11

12

13

14

15

16

PRECAUTIONS

Please read all safety and operating instructions before using this transceiver. For best results, be aware of all warnings on the transceiver and follow these operating instructions. Retain these safety and operating instructions for future reference.

1 Power Source

Connect this transceiver only to the power source described in the operating instructions or as marked on the transceiver itself.

2 Power Cable Protection

Route all power cables safely. Ensure the power cables can neither be walked upon nor pinched by items placed near or against the cables. Pay particular attention to locations near AC receptacles, AC outlet strips and points of entry to the transceiver.

3 Electrical Shocks

Take care not to drop objects or spill liquids into the transceiver through enclosure openings. Metal objects, such as hairpins or needles, inserted into the transceiver may contact voltages resulting in serious electrical shocks. Never permit children to insert any objects into this transceiver.

4 Grounding and Polarization

Do not attempt to defeat methods used for grounding and electrical polarization in the transceiver, particularly involving the input power cable.

5 Outdoor Antenna Grounding

Adequately ground all outdoor antennas used with this transceiver using approved methods. Grounding helps protect against voltage surges caused by lightning. It also reduces the chance of a build-up of static charges.

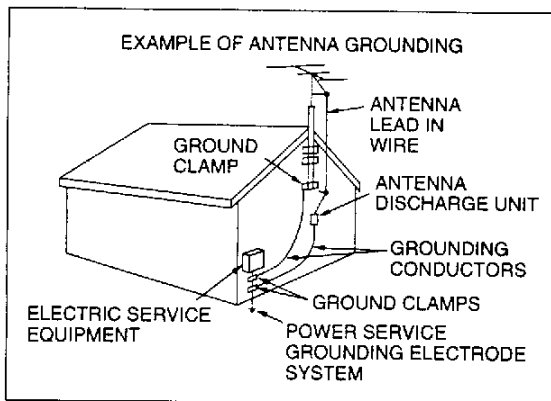

6 Power Lines

Minimum recommended distance for an outdoor antenna from power lines is one and one-half times the vertical height of the associated antenna support structure. This distance allows adequate clearance from the power lines if the support structure should fail for any reason.

7 Ventilation

Locate the transceiver so as not to interfere with its ventilation. Do not place books or other equipment on the transceiver that may impede the free movement of air. Allow a minimum of 4 inches (10 cm) between the rear of the transceiver and the wall or operating desk shelf.

8 Water and Moisture

Do not use the transceiver near water or sources of moisture. For example, avoid use near bathtubs, sinks, swimming pools, and in damp basements and attics.

9 Abnormal Odors

The presence of an unusual odor or smoke is often a sign of trouble. Immediately turn the power OFF and remove the power cable. Contact a dealer or the nearest Service Center for advice.

10 Heat

Locate the transceiver away from heat sources such as radiators, stoves, amplifiers or other devices that produce substantial amounts of heat.

11 Cleaning

Do not use volatile solvents such as alcohol, paint thinner, gasoline or benzene to clean the cabinet. Use a clean cloth with warm water or a mild detergent.

12 Periods of Inactivity

Disconnect the input power cable from the power source when the transceiver is not used for long periods of time.

13 Servicing

Remove the transceiver's enclosure only to do accessory installations described by this manual or accessory manuals. Follow provided instructions carefully to avoid electrical shocks. If unfamiliar with this type of work, seek assistance from an experienced individual, or have a professional technician do the task.

14 Damage Requiring Service

Enlist the services of qualified personnel in the following cases:

- The power supply or plug is damaged.
- Objects have fallen or liquid has spilled into the transceiver.
- The transceiver has been exposed to rain.
- The transceiver is operating abnormally or performance has degraded seriously.
- The transceiver has been dropped or the enclosure damaged.

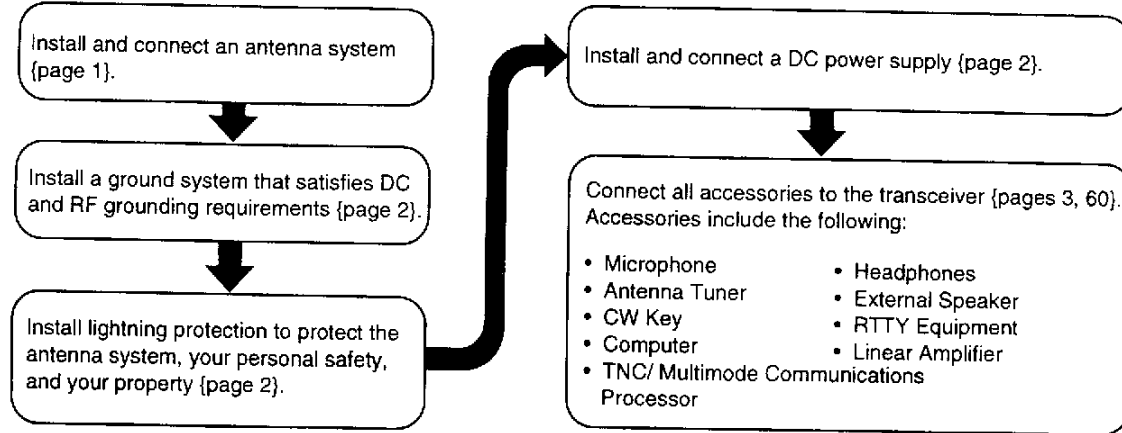

ANTENNA CONNECTION

The type of the antenna system, consisting of the antenna, ground, and feed line, will greatly affect the successful performance of the transceiver. Use a properly adjusted 50 Ω antenna of good quality to let your transceiver perform at its best. Use a good-quality 50 Ω coaxial cable and a first-quality connector for the connection. Match the impedance of the coaxial cable and antenna so that the SWR is 1.5:1 or less. All connections must be clean and tight.

While the transceiver's protection circuit will activate if the SWR is greater than 2.5:1, do not rely on protection to compensate for a poorly functioning antenna system. High SWR will cause the transmit output to drop, and may lead to radio frequency interference to consumer products such as stereo receivers and televisions. You may even interfere with your own transceiver. Reports that your signal is garbled or distorted, especially at peak modulation, may indicate that your antenna system is not efficiently radiating the transceiver's power. If you feel a tingle from the transceiver's cabinet or the microphone's metal fittings when you modulate, you can be certain that, at the least, your coax connector is loose at the rear of the radio and, at the worst, your antenna system is not efficiently radiating power.

Connect your antenna feed line to **ANT 1**. If you are using two antennas, connect the second antenna to **ANT 2**.

CAUTION:

- ◆ TRANSMITTING WITHOUT FIRST CONNECTING AN ANTENNA OR OTHER MATCHED LOAD MAY DAMAGE THE TRANSCEIVER. ALWAYS CONNECT THE ANTENNA TO THE TRANSCEIVER BEFORE TRANSMITTING.
- ◆ USE A LIGHTNING ARRESTOR TO PREVENT FIRE, ELECTRIC SHOCK, OR DAMAGE TO THE TRANSCEIVER.

APPROX. LOSS (dB) PER 30 METERS (100 FEET) OF CORRECTLY MATCHED 50 Ω LINE

- Use only as a general guide. Specifications may vary between cable manufacturers.

Transmission Line	3.5 MHz	14 MHz	30 MHz
RG-174, -174A	2.3	4.3	6.4
RG-58A, -58C	0.75	1.6	2.6
3D-2V	0.80	1.5	2.3
RG-58, -58B	0.65	1.5	2.3
RG-58 Foam	0.70	1.4	2.1
RG-8X	0.50	1.0	2.0
5D-2V	0.45	0.93	1.4
RG-8, -8A, -9, -9A, -9B, -213, -214, -215	0.38	0.80	1.2
5D-FB	N/A	0.80	1.0
RG-8 Foam	0.29	0.60	0.90
8D-2V	0.29	0.60	0.90
10D-2V	0.24	0.50	0.72
9913	0.24	0.48	0.70
8D-FB	N/A	0.48	0.68
10D-FB	N/A	0.37	0.54
12D-FB	N/A	0.33	0.45
RG-17, -17A	0.13	0.29	0.48
1/2" Hardline	0.12	0.26	0.40
20D-2V	< 0.10	0.25	0.39
3/4" Hardline	< 0.10	0.21	0.32
7/8" Hardline	< 0.10	0.16	0.26

N/A: Not available

1 INSTALLATION

1

GROUND CONNECTION

At the minimum, a good DC ground is required to prevent such dangers as electric shock. For superior communications results, a good RF ground is required, against which the antenna system can operate. Both of these conditions can be met by providing a good earth ground for your station. Bury one or more ground rods, or a large copper plate under the ground, and connect this to the transceiver GND terminal. Use heavy gauge wire or a copper strap, cut as short as possible, for this connection. Just as for antenna work, all connections must be clean and tight.

LIGHTNING PROTECTION

Consider carefully how to protect your equipment and your home from lightning. Even in areas where lightning storms are less common, there are usually a limited number of storms each year. Take the time to study the best way to protect your installation from the effects of lightning by consulting reference material on the subject.

The installation of a lightning arrester is a start, but there is more that you can do. For example, terminate your antenna system transmission lines at an entry panel that you install outside your home. Ground this entry panel to a good outside ground, and then connect appropriate feed lines between the entry panel and your transceiver. When a lightning storm occurs, you can ensure added protection by disconnecting the feed lines from your transceiver.

CAUTION: DO NOT ATTEMPT TO USE A GAS PIPE (WHICH IS CLEARLY DANGEROUS), AN ELECTRICAL CONDUIT (WHICH HAS THE WHOLE HOUSE WIRING ATTACHED AND MAY ACT LIKE AN ANTENNA), OR A PLASTIC WATER PIPE FOR A GROUND.

DC POWER SUPPLY CONNECTION

In order to use this transceiver, you will need a separate 13.8 V DC power supply that must be purchased separately. DO NOT directly connect the transceiver to an AC outlet! Use the supplied DC power cable to connect the transceiver to a regulated power supply. Do not substitute a cable with smaller gauge wires. The current capacity of your power supply must be 20.5 A peak or more.

CAUTION:

- ◆ BEFORE CONNECTING THE DC POWER SUPPLY TO THE TRANSCEIVER, BE SURE TO SWITCH THE TRANSCEIVER AND THE DC POWER SUPPLY OFF.
- ◆ DO NOT PLUG THE DC POWER SUPPLY INTO AN AC OUTLET UNTIL YOU MAKE ALL CONNECTIONS.

First connect the DC power cable to the regulated DC power supply and check that polarities are correct (Red: positive, Black: negative). Then connect the connectorized end of the DC power cable to the **DC 13.8 V** power connector on the transceiver rear panel. Press the DC power cable connector firmly into the connector on the transceiver until the locking tab clicks.

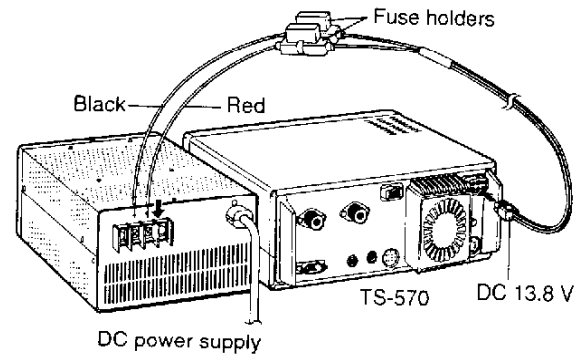

REPLACING FUSES

If the fuse blows, determine the cause then correct the problem. After the problem is resolved, only then replace the fuse. If newly installed fuses continue to blow, disconnect the power plug and contact your dealer or nearest Service Center for assistance.

Fuse Location	Fuse Current Rating
TS-570	4 A (For an external antenna tuner)
Supplied Accessory Cable	25 A

CAUTION: REPLACE BLOWN FUSES ONLY AFTER INVESTIGATING AND CORRECTING THE CAUSE OF THE FAILED FUSE. ALWAYS REPLACE A BLOWN FUSE BY A NEW FUSE WITH THE SPECIFIED RATINGS.

ACCESSORY CONNECTIONS

FRONT PANEL

■ Headphones (PHONES)

Use headphones having 4 to 32 Ω impedance. You can also use stereo headphones. When headphones are used, no sound is heard from the internal (or optional external) speaker. Use a 6.0 mm (1/4") diameter, 2-conductor (mono) or 3-conductor (stereo) plug.

■ Microphone (MIC)

To communicate in the voice modes, connect to the MIC connector a microphone having an impedance between 250 Ω and 600 Ω . Insert the connector from your microphone fully, then screw the retaining ring clockwise until snug. Compatible microphones include the MC-43S, MC-47, MC-60A, MC-80, MC-85, and MC-90. Do not use the MC-44, MC-44DM, MC-45, MC-45E, MC-45DM, MC-45DME, MC-52DM, or MC-53DM microphone.

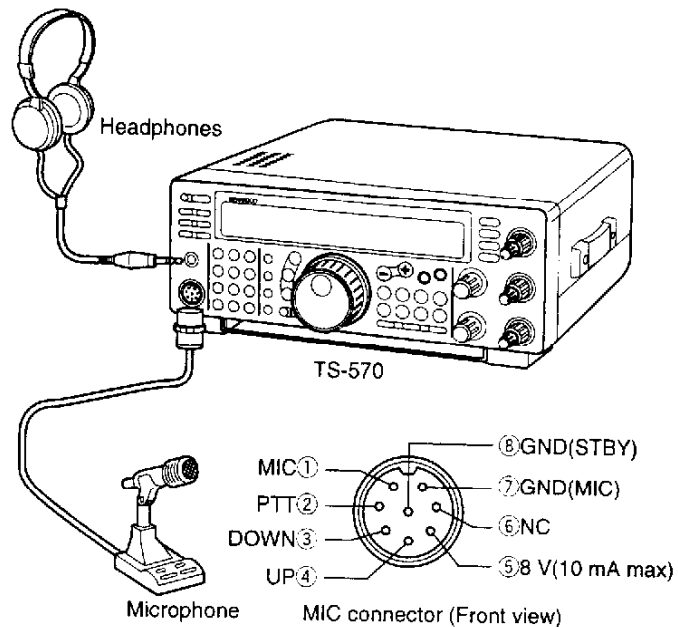

REAR PANEL

■ External Speaker (EXT SP)

Ensure any external speaker used has an impedance of 8 Ω . Use a 3.5 mm (1/8") diameter, 2-conductor (mono) plug. When an external speaker is used, no sound is heard from the internal speaker.

WARNING! DO NOT CONNECT HEADPHONES TO THIS JACK. THE HIGH AUDIO OUTPUT AT THIS JACK COULD DAMAGE YOUR HEARING.

■ Keys and Keyboards for CW Operation (PADDLE and KEY)

For CW operation using the internal electronic keyer, connect a keyer paddle to the **PADDLE** jack. For CW operation without using the internal electronic keyer, connect a straight key, semi-automatic key (bug), electronic keyer, or the CW keyed output from a Multimode Communications Processor (MCP) to the **KEY** jack. The jacks mate with a 6.0 mm (1/4") 3-conductor plug and a 3.5 mm (1/8") 2-conductor plug respectively. External electronic keyers or MCPs must use positive keying to be compatible with this transceiver. Use a shielded cable between the key and the transceiver.

Note: Due to the full-featured functionality of the internal electronic keyer, you may decide it's unnecessary to connect both a paddle and another type of key unless you specifically want to use a keyboard for CW. It's recommended that you become familiar with the internal keyer by reading "ELECTRONIC KEYER" (page 34) before making your decision.

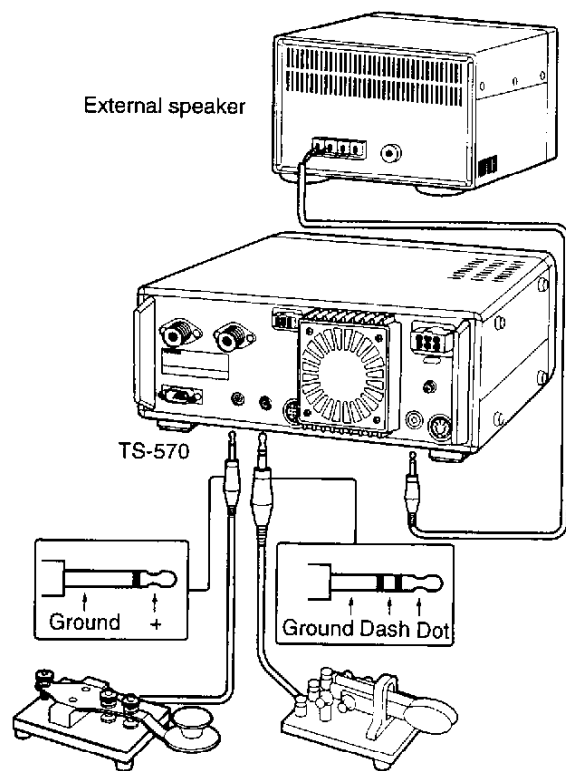

- Straight key
- Bug
- Electronic keyer
- MCP CW output

- Paddle

2 YOUR FIRST QSO

Since you've now installed the TS-570, why not try it? The instructions below are abbreviated. They are intended only to act as a quick introduction. If you encounter problems or there's something you don't understand, you can read about the subject in more detail later.

RECEIVING

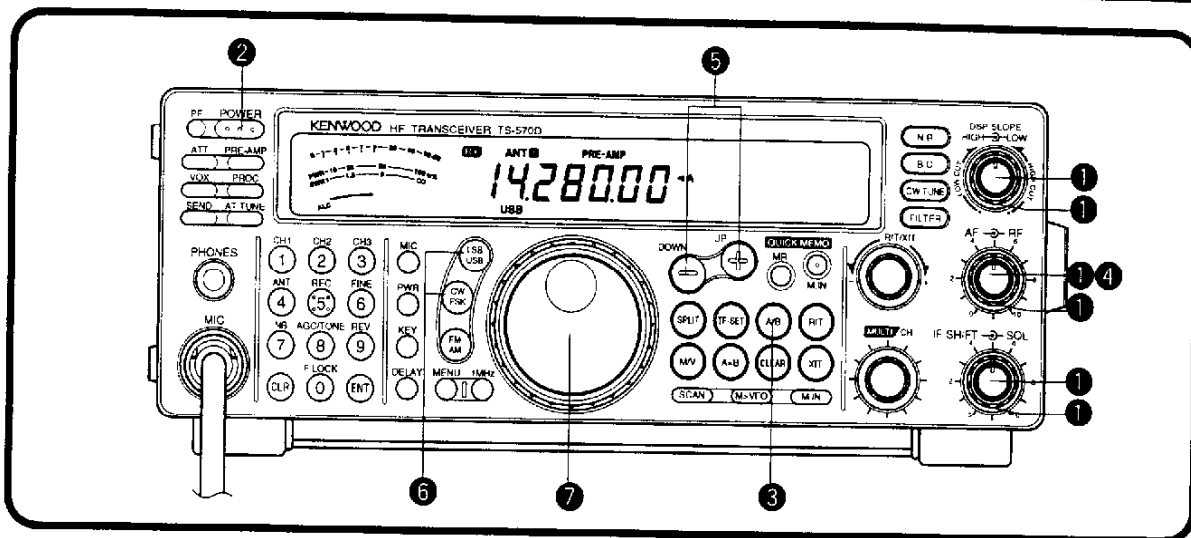

Note: Only those buttons and controls required to briefly try the transceiver are explained in this section.

1 Set the following as specified:

- **AF** control: Fully counterclockwise
- **RF** control: Fully clockwise
- **DSP SLOPE (HIGH)** control: Fully clockwise
- **DSP SLOPE (LOW)** control: Fully counterclockwise
- **IF SHIFT** control: Center
- **SQL** control: Fully counterclockwise

2 Switch ON the DC power supply, then press and hold the **[POWER]** switch briefly.

- The transceiver switches ON. Indicators and frequency digits should appear on the display.



- Note that pressing **[POWER]** for more than approximately 2 seconds switches the transceiver power OFF.

3 VFO A should already be selected for receiving and transmitting, and you should see "◀A" on the display. If not, press the **[A/B]** button.

4 Increase the **AF** control slowly clockwise until you hear a suitable level of background noise.

5 Select an Amateur band by pressing the **[UP]** or **[DOWN]** button.

6 Select an operating mode by pressing the **[LSB/USB]** or **[CW/FSK]** button.

- Press the same button again to toggle to the second function on the button. For example, repeatedly pressing the **[LSB/USB]** button switches between LSB and USB modes.

7 Turn the **Tuning** control to tune in a station.

- If no stations are heard but you have an antenna connected, possibly the wrong antenna connector is selected. Pressing the **[ANT]** button toggles between the Antenna 1 and the Antenna 2 connectors.

TRANSMITTING

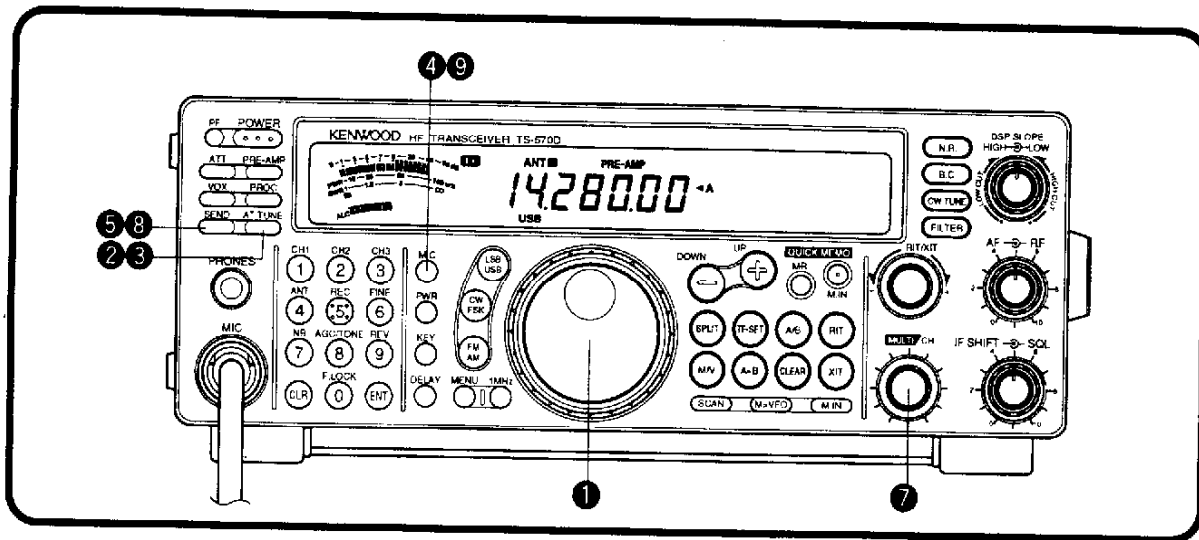

After tuning in a few stations as explained in the previous section "RECEIVING", try making a contact.

1 Assuming you are already on the correct band with the correct mode selected (steps 1-7 in "RECEIVING"), use the **Tuning** control to tune in a station or to select an unused frequency.

2 Momentarily press the [AT TUNE] button.

- "AT" appears.

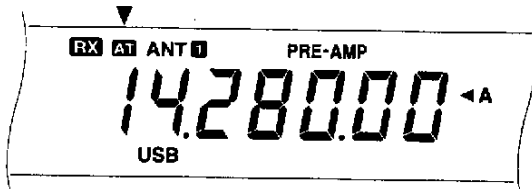

3 Press and hold the [AT TUNE] button to allow the built-in antenna tuner to function.

- "AT" blinks and "TX" appears.

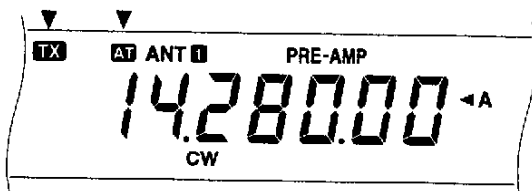

- Tuning should be completed in less than approximately 20 seconds. "AT" stops blinking and "TX" disappears.
- If tuning is not completed in approximately 20 seconds, error beeps sound. Press [AT TUNE] to stop the error beeps and to quit tuning. Check your antenna system before continuing.

Note: Tuning will automatically turn off after approximately 60 seconds. In addition, "AT" will disappear and the error beeps will stop.

4 **SSB:** Press the [MIC] button to activate the Microphone Gain Setting function.

- "MIC-50" appears.

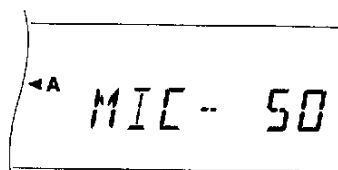

CW: Skip this step.

5 Press the [SEND] button.

- "TX" appears.

6 Begin speaking into the microphone or sending CW with your key.

7 **SSB:** While speaking into the microphone, adjust the **MULT/CH** control so that the ALC meter reflects according to your voice level.

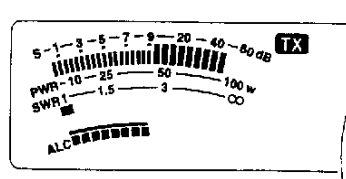

CW: Skip this step.

8 Press the [SEND] button again when you want to return to receive mode.

9 Press the [MIC] button again to quit the Microphone Gain Setting function.

This completes your introduction to the TS-570, but there is a great deal more to know. "OPERATING BASICS" (page 13) and following chapters explain all functions of the transceiver starting with the most basic, commonly-used functions.

GETTING ACQUAINTED

FRONT PANEL

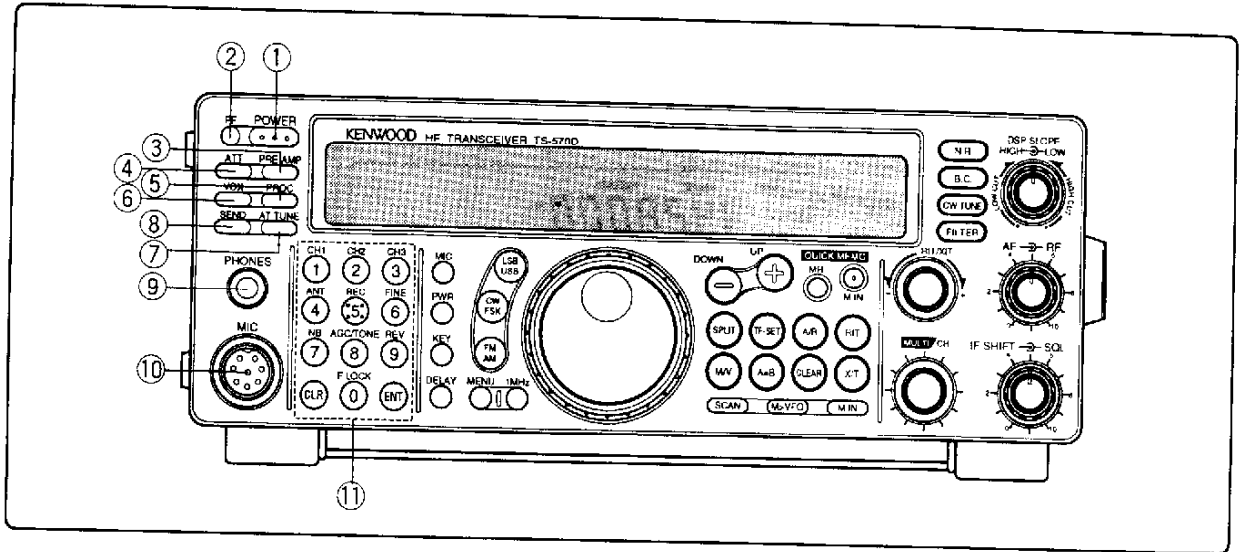

3

① POWER switch

Press and hold down briefly to switch ON the transceiver power. Press again to switch OFF the power {page 13}.

② PF button

A function can be assigned by the user to this Programmable Function button {page 49}. The default function is Voice 1 {page 55}.

③ PRE-AMP button

Press to switch ON or OFF the receive preamplifier {page 37}.

④ ATT button

Press to switch ON or OFF the receive attenuator {page 37}.

⑤ PROC button

Press to switch ON or OFF the Speech Processor for transmitting {page 32}.

⑥ VOX button

In voice modes, press to switch ON or OFF the Voice-Operated Transmit function {page 31} or, in CW mode, to switch ON or OFF the Break-in function {page 34}.

⑦ AT TUNE button

Use for activating the internal antenna tuner {page 52} or an external antenna tuner.

⑧ SEND button

Press to switch the transceiver between receive mode and transmit mode {page 15}.

⑨ PHONES jack

Connect headphones to this jack. Inserting a plug into the jack automatically mutes the audio from the speaker {page 3}.

⑩ MIC connector

Connect a compatible microphone, then snugly screw down the connector locking ring {page 3}.

⑪ Multi-purpose keypad

Consists of 10 buttons that are used for inputting numeric data. Also used for the following functions.

• CH 1, CH 2, CH 3 buttons

Press to select functions associated with the internal electronic keyer {page 34} and the DRU-3A Digital Recording Unit {page 53}.

• ANT button

Press to select either Antenna 1 or Antenna 2 that are connected to their respective antenna connectors on the rear panel {pages 1, 48}.

• REC button

Press to select the record mode for CW Message Memory {page 35} or for the optional DRU-3A Digital Recording Unit {page 53}.

• FINE button

Press to reduce by one-tenth the **Tuning** control step size to allow more precise tuning {page 30}.

• NB button

Press to switch ON or OFF the analog Noise Blanker {page 36}.

• AGC/TONE button

Press to switch the Automatic Gain Control function between Slow and Fast {page 30}. Also switches ON or OFF the Subtone {page 24} or CTCSS function {page 25}.

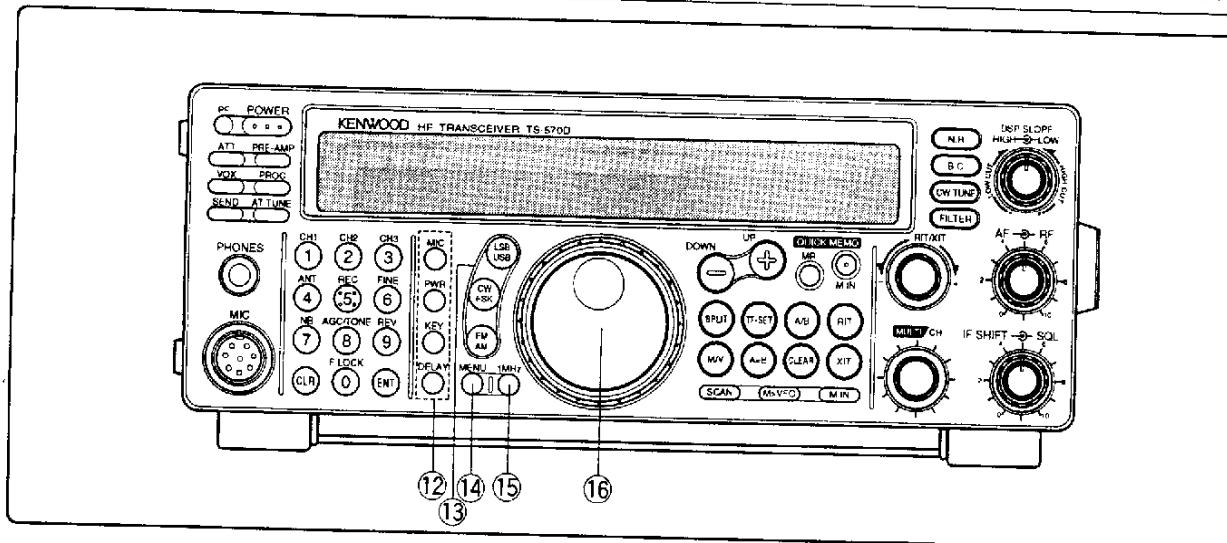

- **REV** button
In CW or FSK mode, press to select either the upper or lower sideband while receiving (pages 21, 26).
 - **CLR** button
Press to exit from, abort, or reset various functions. Also used for erasing memory channels (page 43) or for locking out memory channels from the scan list (page 44).
 - **F.LOCK** button
Press to switch ON or OFF the Frequency Lock function (page 48).
 - **ENT** button
Press to enter the desired frequency via the keypad (page 29).
- ⑫ **Transmit function buttons**
Used in conjunction with the **MULTI/CH** control to set various transmit functions.
- **MIC** button
Used for setting the microphone gain level (page 15).
 - **PWR** button
Used for setting the transmit output power (page 15).
 - **KEY** button
Used for setting the internal electronic keyer speed (page 34).
 - **DELAY** button
When using the VOX or Break-in function, used for setting the time delay from transmit mode to receive mode (pages 31, 34).
- ⑬ **Mode buttons**
Press these buttons to select your operating mode (page 14).
- **LSB/USB** button
Press to select lower sideband or upper sideband mode for voice or digital operation (pages 20, 27).
 - **CW/FSK** button
Press to select CW or frequency shift keying mode (pages 21, 26).
 - **FM/AM** button
Press to select FM or AM mode (page 22).
- ⑭ **MENU** button
Press to select or cancel the Menu mode that is used for activating and configuring functions (page 16).
- ⑮ **1MHz** button
Press to switch between the 1 MHz step mode and the Amateur band mode (page 29).
- ⑯ **Tuning** control
Turn to select the desired frequency (page 14). Use the convenient finger-tip cavity for continuous tuning.
The lever behind the control adjusts the control torque level; turn fully clockwise for light torque or fully counterclockwise for slightly heavy torque.

3 GETTING ACQUAINTED

3

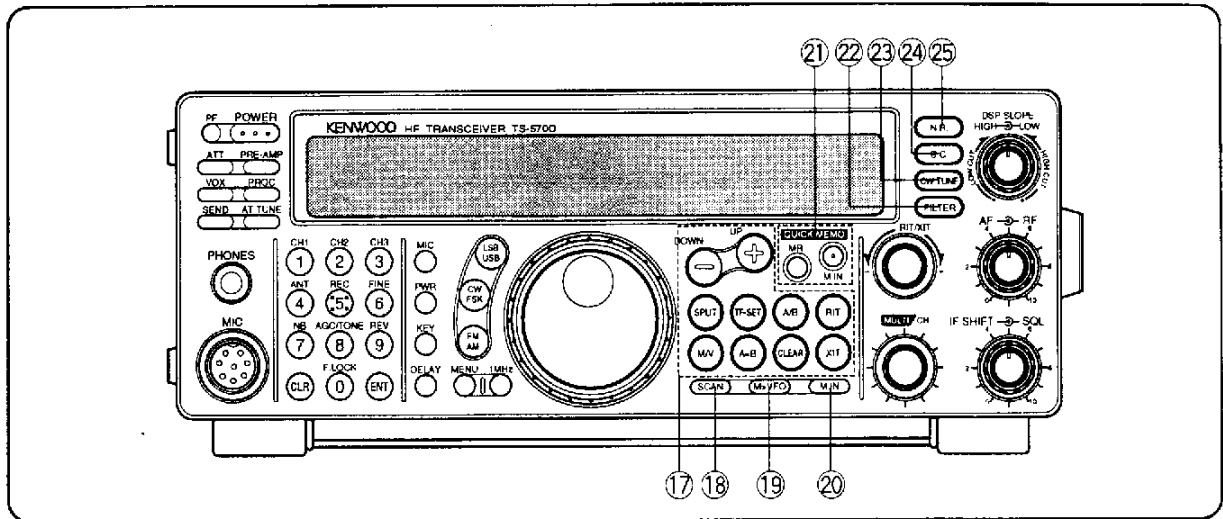

17 Frequency control buttons

These buttons control functions related to selecting a frequency, a VFO, or a memory channel.

- **UP/DOWN** buttons
Press to step through all Amateur bands consecutively (page 13) or to step the transceiver frequency in 1 MHz increments (page 29). Also used for making selections from the Menu (page 16), and to check Start and End frequencies for the Scan function (page 43).
- **SPLIT** button
Press to use split-frequency operation which allows a different transmit frequency and receive frequency (page 23).
- **M/V** button
Press to select either Memory or VFO mode (page 40).
- **TF-SET** button
While operating split-frequency, press to monitor or change your transmit frequency (page 23).
- **A=B** button
Press to copy the data in the currently selected VFO over to the other VFO (page 30).
- **A/B** button
Press to select either VFO A or VFO B (page 13). Also, in menu mode, press to select either Menu A or Menu B (page 16).
- **CLEAR** button
Press to reset the RIT/XIT frequency offset to zero (pages 30, 32).
- **RIT** button
Press to switch ON or OFF the Receive Incremental Tuning function (page 30).
- **XIT** button
Press to switch ON or OFF the Transmit Incremental Tuning function (page 32).

18 SCAN button

Press to start and stop Scan functions (pages 46, 47).

19 M->VFO button

Press to transfer data from a memory channel to a VFO (page 42).

20 M.IN button

Writes data into a memory channel (page 39) or selects Memory Scroll mode (page 41).

21 Quick Memory buttons

Controls the Quick Memory function (page 44).

- **M.IN** button
Press to write data into Quick Memory (page 44).
- **MR** button
Press to recall data from Quick Memory (page 45).

22 FILTER button

Press to select the receive filter bandwidth in SSB, CW, FSK, or AM mode (pages 36, 38), or press to select either narrow-band or wide-band transmit deviation in FM mode (page 22).

Note: Selecting the narrow filter bandwidth in SSB mode requires the optional YK-88SN-1 filter (page 36).

23 CW TUNE button

Press to activate the automatic zero-beat function for CW mode (page 21).

24 B.C. button

Press to switch ON or OFF the DSP Beat Cancel function (page 38).

25 N.R. button

Press to toggle between Noise Reduction 1, Noise Reduction 2, and OFF (page 38).

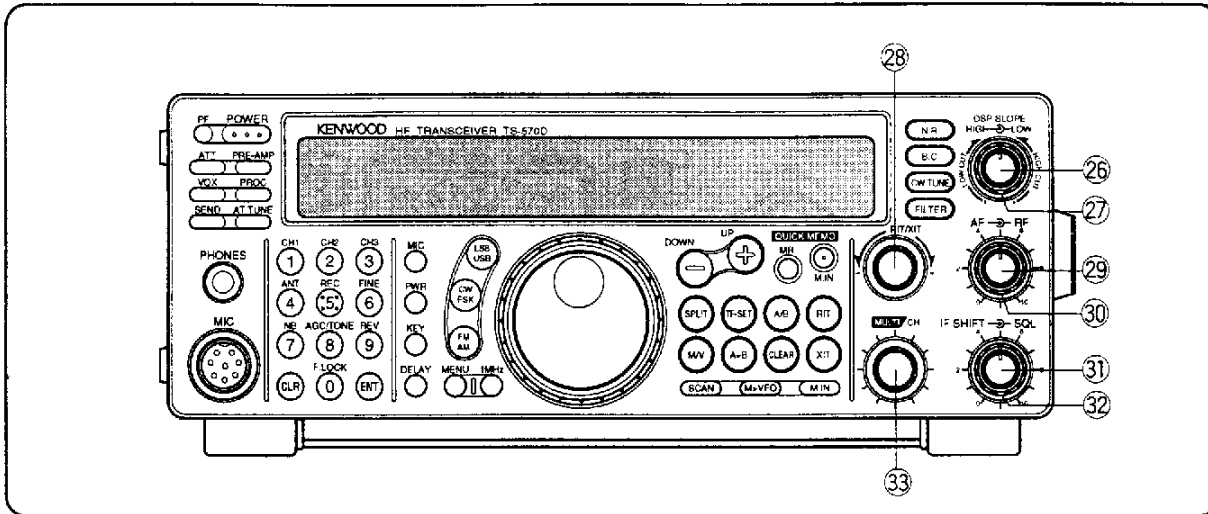

3

26 DSP SLOPE (HIGH) control

In SSB or AM mode, turn to change the high cut-off frequency of the receive pass band. Use the control to improve readability of the desired signal when higher frequency interference is present {page 37}.

27 DSP SLOPE (LOW) control

In SSB or AM mode, turn to change the low cut-off frequency of the receive pass band. Use the control to improve readability of the desired signal when lower frequency interference is present {page 37}.

28 RIT/XIT control

After switching ON the RIT or XIT function, turn to select the desired frequency offset {pages 30, 32}.

29 AF control

Turn to adjust the audio frequency gain {page 13}.

30 RF control

Turn to adjust the radio frequency gain {page 13}.

31 IF SHIFT control

Turn to slide the receive pass band either lower or higher in frequency when interference is present {page 36}.

32 SQL control

Used for muting (“squenching”) the speaker output when no receive signal is present {page 14}.

33 MULTI/CH control

In VFO mode, turn to step the operating frequency up or down {page 29}. In memory channel mode, turn to select a memory channel {page 40}. Also used for selecting Menu numbers when accessing the Menu mode {page 16}, and as a selector to choose settings for various functions activated by front panel buttons.

MICROPHONE

1 UP/DWN buttons

Use these buttons to step up or down the VFO frequency, memory channels, or Menu selections. Press and hold down to continuously change the settings.

2 PTT (Push-to-Talk) switch

The transceiver is placed in transmit mode when this non-locking switch is held down. Releasing the switch returns the transceiver to receive mode.

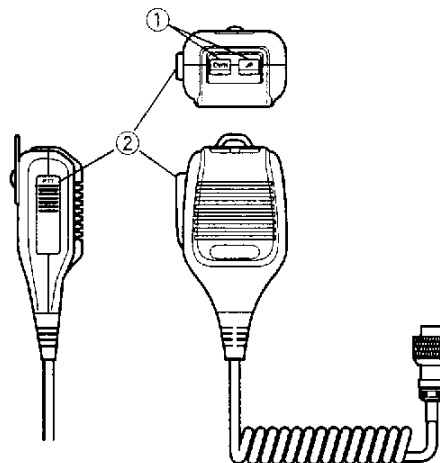

3 GETTING ACQUAINTED

REAR PANEL

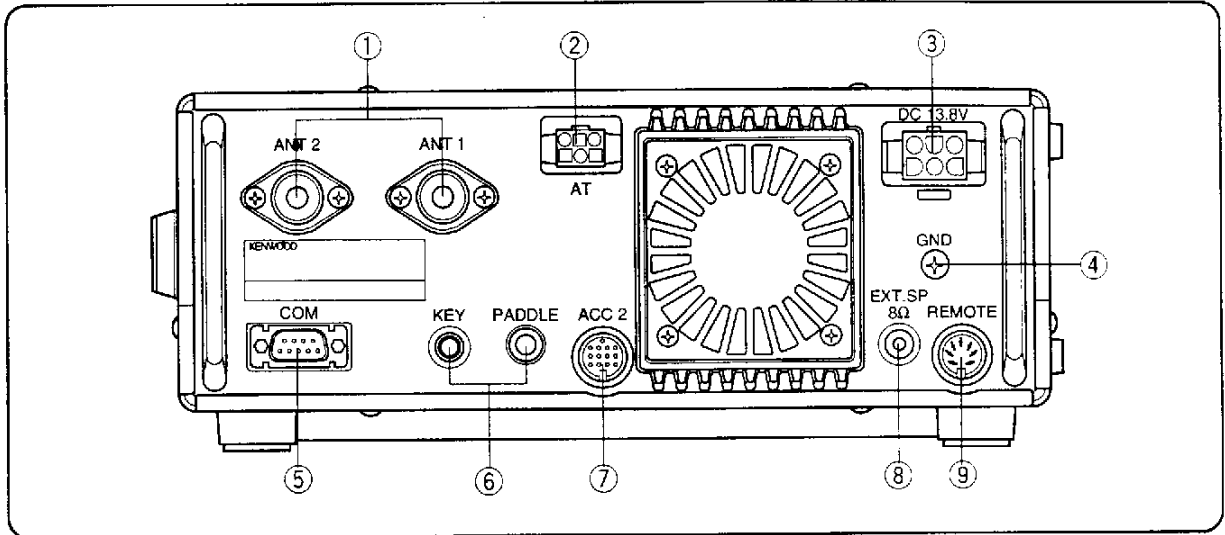

① **ANT 1** and **ANT 2** connectors

Connect the feed lines from your antennas to these connectors. Refer to pages 1 and 48 for details.

② **AT** connector

Mates with the connector on the cable supplied with the external antenna tuner. Refer to the instruction manual supplied with this tuner for more information.

③ **DC 13.8 V** power input connector

Connect a 13.8 V DC power source (page 2). Use the supplied cable with a regulated DC power supply.

④ **GND** post

Connect a heavy gauge wire or copper strap between the ground post and the nearest earth ground (page 2).

⑤ **COM** connector

Mates with a 9-pin female RS-232C connector for connecting a computer via one of its serial communication ports (page 60). Also used with the Quick Data Transfer function (page 60).

⑥ **KEY** and **PADDLE** jacks

The **PADDLE** jack mates with a 6.0 mm (1/4") 3-conductor plug for connecting a keyer paddle to the internal electronic keyer. The **KEY** jack mates with a 3.5 mm (1/8") 2-conductor plug for connecting an external key for CW operation. Read "Keys and Keyboards for CW Operation" (page 3) before connecting to these jacks.

⑦ **ACC 2** connector

Mates with a 13-pin male DIN connector for connecting various accessory equipment (pages 61, 62).

⑧ **EXT SP** jack

Mates with a 3.5 mm (1/8"), 2-conductor (mono) plug for connecting an external speaker (page 3). Connecting an external speaker cuts off the audio automatically to the internal speaker.

⑨ **REMOTE** connector

Mates with a 7-pin male DIN connector for connecting a linear amplifier (page 61).

European versions only: Before connecting to the **ACC2** and **COM** connectors, remove the protective covers.

DISPLAY

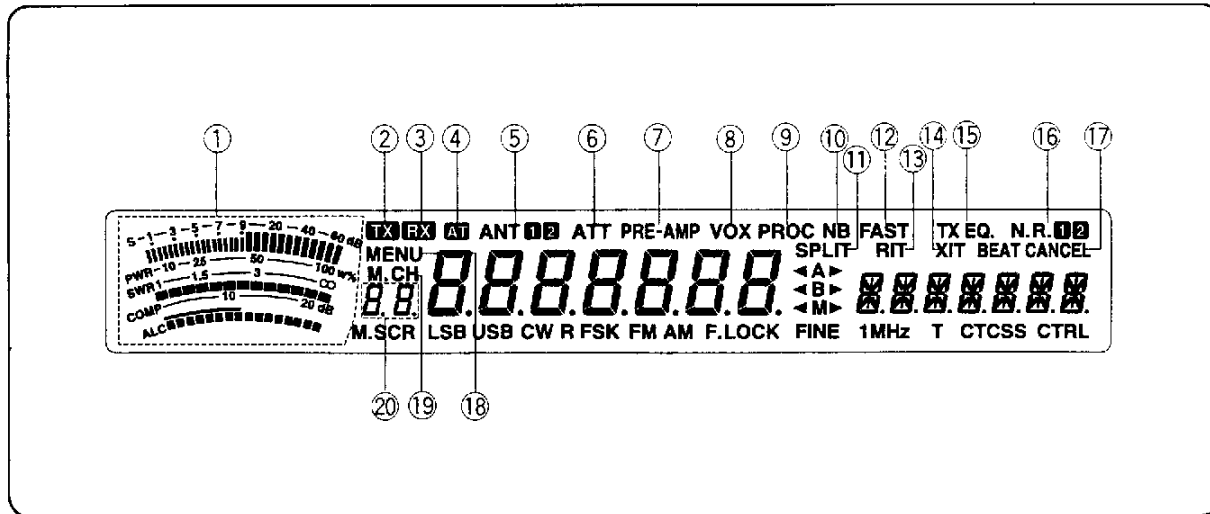

3

① METER

While receiving, serves as an S-meter to measure and display the received signal strength. While transmitting, serves as a calibrated power meter plus an ALC meter, an SWR meter, or a Speech Processor compression meter. The Peak Hold function holds each reading for about 2.5 seconds.

② TX

Appears while the transceiver is in the transmit mode.

③ RX

Appears while the squelch is open in the receive mode.

④ AT

Appears while the internal antenna tuner {page 52} or an external antenna tuner is in-line.

⑤ ANT 1 2

Either "ANT 1" or "ANT 2" appears depending on whether the Antenna 1 connector or the Antenna 2 connector is selected {page 48}.

⑥ ATT

Appears when the receive attenuator is ON {page 37}.

⑦ PRE-AMP

Appears when the receive preamplifier is ON {page 37}.

⑧ VOX

Appears when the Voice-Operated Transmit function is ON {page 31}. For CW operation, appears when the Break-in function is ON {page 34}.

⑨ PROC

Appears when Speech Processor is ON {page 32}.

⑩ NB

Appears when Noise Blanker is ON {page 36}.

⑪ SPLIT

Appears when the transmit frequency differs from the receive frequency {page 23}.

⑫ FAST

Appears when a fast time constant is selected for the Automatic Gain Control function {page 30}.

⑬ RIT

Appears when Receive Incremental Tuning is ON {page 30}.

⑭ XIT

Appears when Transmit Incremental Tuning is ON {page 32}.

⑮ TX EQ.

Appears when the TX Equalizer function is ON {page 33}.

⑯ N.R. 1 2

Either "N.R. 1" or "N.R. 2" appears depending on whether Noise Reduction 1 or Noise Reduction 2 is selected {page 38}.

⑰ BEAT CANCEL

Appears when Beat Cancel is ON {page 38}.

⑱ MENU

Appears while Menu mode is being accessed {page 16}.

⑲ M.CH

Appears while Memory Recall or Memory Scroll is being used {page 40}.

⑳ B.B.

Shows 2-digit information such as a menu number or a memory channel number.

3 GETTING ACQUAINTED

3

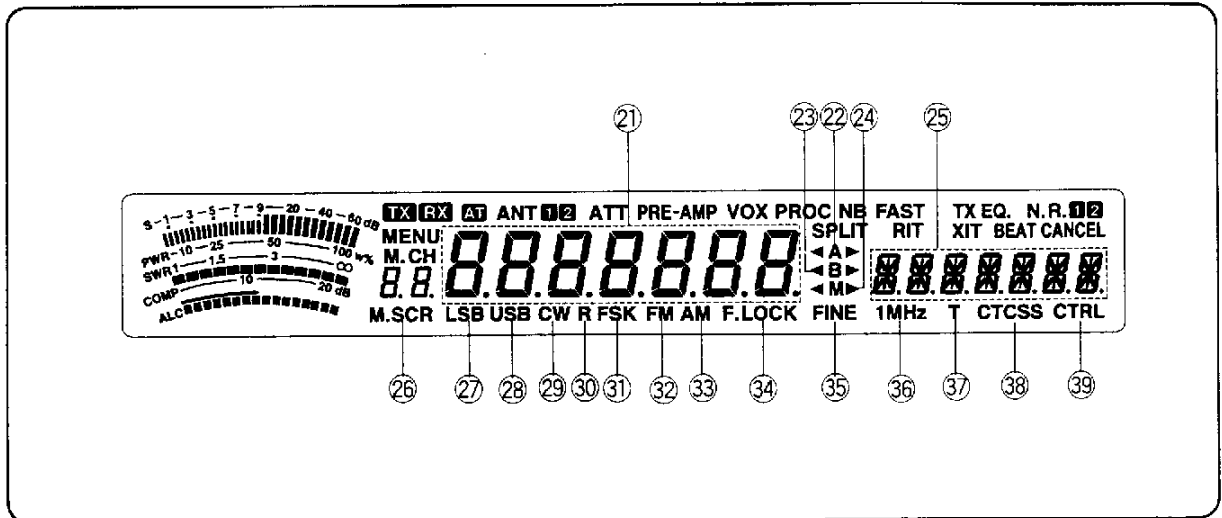

21 **88888888**

Shows the current operating frequency. Also shows Menu selections while in Menu mode.

22 **<A>**

"<A" or "A" appears while VFO A is being selected {page 13}. "A" appears while Menu A is being accessed {page 16}.

23 ****

"<B" or "B" appears while VFO B is being selected {page 13}. "B" appears while Menu B is being accessed {page 16}.

24 **<M>**

"<M" or "M" appears while a simplex memory channel is being selected {page 40}. "<M" appears while a split-frequency memory channel is being selected {page 40}.

25 **XXXXXXXXXX**

Shows menu information while Menu A or B is being accessed. Also shows the transmit frequency during split-frequency operation, and the RIT/XIT offset frequency when these functions are ON.

26 **M.SCR**

Appears while Memory Scroll is being used {page 41}.

27 **LSB**

Appears when in Lower Sideband mode {page 14}.

28 **USB**

Appears when in Upper Sideband mode {page 14}.

29 **CW**

Appears when in CW mode {page 14}.

30 **R**

Appears while the sideband is being reversed for CW {page 21}. Also appears while the mark and space frequency relationship is being reversed for FSK {page 26}.

31 **FSK**

Appears when in Frequency Shift Keying mode {page 26} or when you select one of the digital operation filters via Menu No. 32 in SSB mode {page 27}.

32 **FM**

Appears when in FM mode {page 14}.

33 **AM**

Appears when in AM mode {page 14}.

34 **F.LOCK**

Appears when the Frequency Lock function is ON {page 48}.

35 **FINE**

Appears when the Fine function is ON {page 30}.

36 **1MHz**

Appears when the 1 MHz Step function is ON {page 29}.

37 **T**

Appears when the Subtone function is ON {page 24}.

38 **CTCSS**

Appears when CTCSS is ON {page 25}.

39 **CTRL**

Appears while Quick Data Transfer {page 50} or Computer Control {page 51} is being used.

OPERATING BASICS

SWITCHING POWER ON/OFF

Switch ON the DC power supply, then press and hold down **[POWER]** until "HELLO" appears on the display. Release **[POWER]** when you see "HELLO".

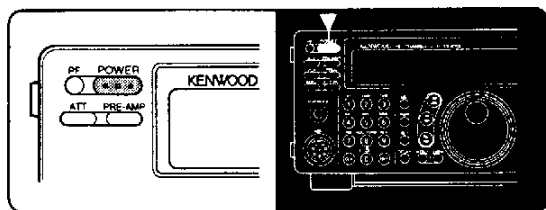

- After the "HELLO" message, the frequency and other indicators appear.

To switch OFF the transceiver, press **[POWER]**.

- After the transceiver has been switched ON, it can then be switched OFF or ON by using only the power switch on the DC power supply.

ADJUSTING VOLUME

AUDIO FREQUENCY (AF) GAIN

Turn the **AF** control clockwise to increase the audio level and counterclockwise to decrease the level.

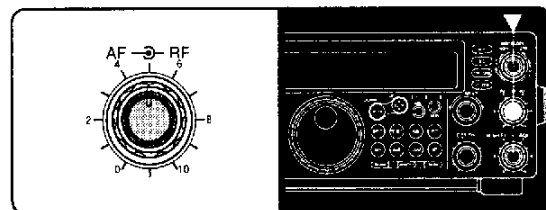

Note: The position of the **AF** control does not affect the volume of "beeps" caused by pressing buttons nor the CW transmit sidetone. Also, the audio level for Packet operation is independent of the **AF** control setting.

RADIO FREQUENCY (RF) GAIN

Usually, set the **RF** control fully clockwise. If you are having trouble hearing the desired signal due to excessive atmospheric noise or interference from other stations, it may help to reduce the RF gain.

To do this, take note of the peak S-meter reading of the desired signal. Turn the **RF** control counterclockwise until the S-meter reads the peak value that you noted. Signals that are weaker than this level will be attenuated. Reception of the station will be easier.

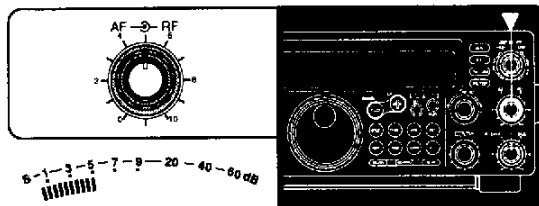

4

Depending on the type and gain of your antenna, and the condition of the band, you may prefer leaving the **RF** control turned counterclockwise by some amount instead of turning it fully clockwise. When in FM mode, always set the **RF** gain control fully clockwise.

SELECTING VFO A OR VFO B

VFO A and VFO B are modes that allow any desired frequency to be selected within the frequency range of the transceiver. VFO A and VFO B function independently so that different or the same frequencies can be selected for each VFO.

Press **[A/B]** to toggle between VFO A and VFO B.

- "◀A" or "◀B" appears and shows which VFO is selected.

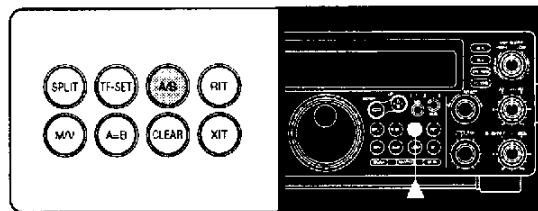

SELECTING A BAND

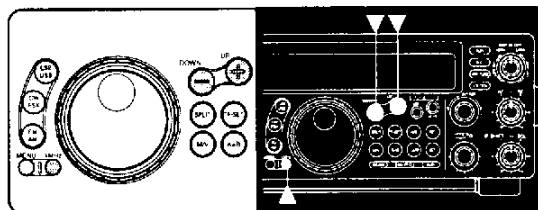

- 1 If "1MHz" is visible on the display, first press **[1MHz]** to exit from the 1MHz Step mode.
 - "1MHz" should disappear.
- 2 Press **[UP]** or **[DOWN]**.
 - Holding down either button consecutively steps the transceiver to each band.

4 OPERATING BASICS

SELECTING A MODE

Depending on which operating mode you want to select, press the **[LSB/USB]**, **[CW/FSK]**, or **[FM/AM]** button. The second function on each button is accessed by again pressing the same button. For example, repeatedly pressing **[LSB/USB]** toggles between LSB and USB modes.

4

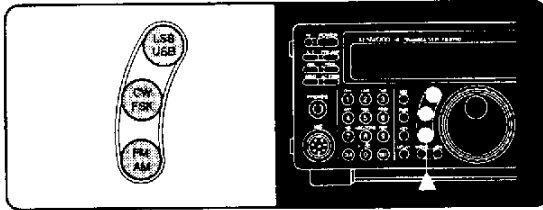

In SSB mode, the transceiver automatically selects LSB for frequencies lower than 9.5 MHz, and selects USB for 9.5 MHz or higher frequencies if the **Tuning** control, the **MULTVCH** control, or Mic **[UP]/[DWN]** is used to cross the frequency of 9.5 MHz. This is also true if using the front panel **[UP]** or **[DOWN]** button when the 1 MHz Step mode is used.

ADJUSTING SQUELCH

The purpose of squelch is to silence audio output from the speaker when no signal is present. When squelch is set correctly, you will hear sound only while a station is actually being received. The point at which ambient noise on a frequency just disappears, called the squelch threshold, depends on the frequency.

Turn the **SQL** control clockwise to just eliminate the background noise when no signal is present. Many operators prefer leaving the squelch control fully counterclockwise unless operating full-carrier modes such as FM or AM.

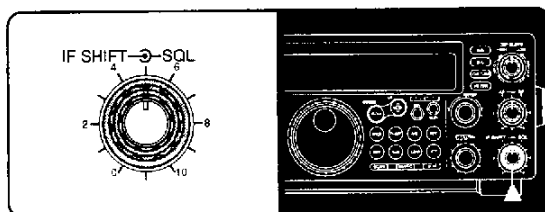

SELECTING A FREQUENCY

There are two simple methods to select a frequency.

A Manual Tuning

Turn the **Tuning** control or press Mic **[UP]/[DWN]** to select the exact frequency.

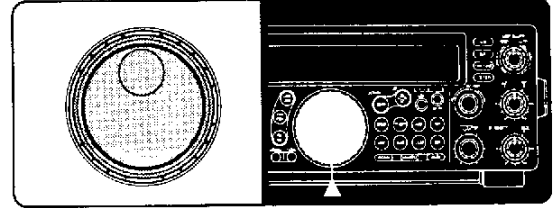

B Direct Frequency Entry (Keypad)

Press **[ENT]**, then directly enter the desired frequency using the numeric keypad. For details, refer to "Direct Frequency Entry" (page 29).

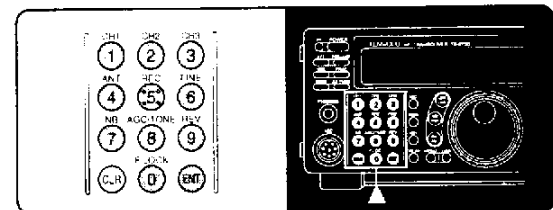

FRONT PANEL METER

The multifunction meter measures the parameters in the table below. The appropriate meters automatically become functional according to which state the transceiver is in. Peak readings for the S-meter, ALC, SWR, COMP, and PWR functions are held for a brief moment.

Scale	Display	Functional State
S	Received signal strength	Receive
PWR	Transmit output power	Transmit
ALC	Automatic level control status	Transmit
SWR	Antenna system standing wave ratio	Transmit
COMP	Speech compression level when using the Speech Processor {page 32}	Transmit plus SSB/AM/FM mode plus [PROC] ON

Note:

- ◆ The **COMP** meter functions only when the Speech Processor is ON while using SSB, FM, or AM mode. When the **COMP** meter appears, the **SWR** meter disappears.
- ◆ Peak Hold readings cannot be deactivated on this transceiver.

TRANSMITTING

Methods for transmitting include the following:

- Press [SEND].
- Press and hold down Mic [PTT].
- Connect a key or keyer paddle, select the CW mode, press [VOX] to switch ON the Break-in function, and close the key or keyer paddle.

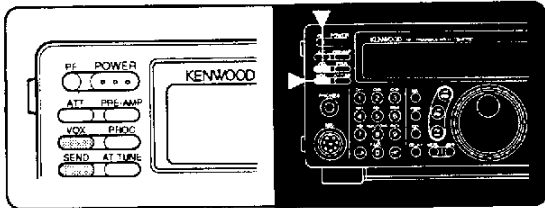

For a detailed explanation on transmitting, refer to sections in "BASIC COMMUNICATING" beginning on page 20.

Note: When CW, FSK, or AM is selected, the transmit carrier level is automatically adjusted according to the selected mode.

SELECTING TRANSMIT POWER

It's wise, and required by law, to select the lowest transmit power that allows reliable communication. Reducing power lowers the risk of interfering with others on the band. On this transceiver, it is possible to change output power while transmitting.

- 1 Press [PWR].
 - The current transmit power appears.

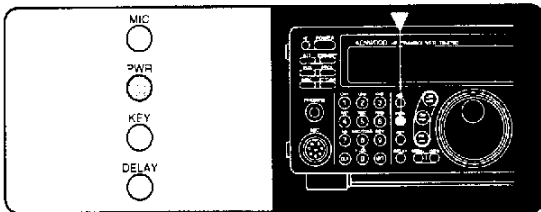

- 2 Turn the **MULTI/CH** control counterclockwise to reduce power and clockwise to increase power.
 - The displayed transmit power changes.

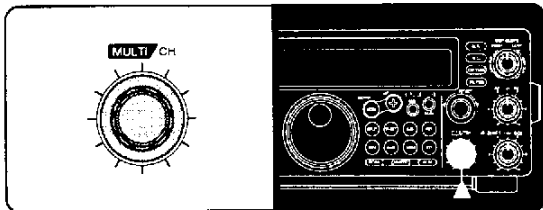

- **SSB/CW/FSK/FM:** Transmit power can be changed from 5 W to 100 W in steps of 5 W.
- **AM:** Transmit power can be changed from 5 W to 25 W in steps of 5 W.

- 3 Press [PWR] again to complete the setting.

Note: The transmit power can be separately selected for the AM mode independent of the other modes.

MICROPHONE GAIN

The microphone gain must be adjusted when SSB or AM mode is used without speech processing (page 32).

- 1 Press [MIC].
 - The current microphone gain level appears. The default is 50.

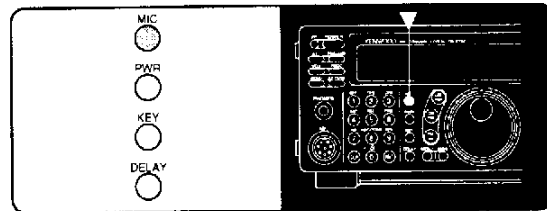

- 2 Press [SEND] or press and hold Mic [PTT].
 - "TX" appears.
- 3 **SSB:** While speaking into the microphone, adjust the **MULTI/CH** control so that the ALC meter reflects according to your voice level.

AM: While speaking into the microphone, adjust the **MULTI/CH** control so that the calibrated power meter slightly reflects according to your voice level.

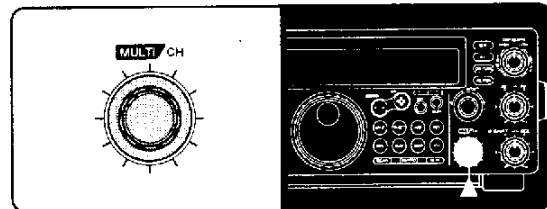

- 4 Press [SEND] again or release Mic [PTT].
 - "TX" disappears.
- 5 Press [MIC] again.

For the FM mode, set the microphone gain by accessing Menu No. 17 (page 17) and selecting either "L" (low) or "H" (high).

Note: When using the optional MC-90 microphone in FM mode, select high microphone gain. The microphone sensitivity is low in FM mode and this may cause insufficient modulation.

4

MENU SETUP

WHAT IS A MENU?

Many functions on this transceiver are selected or configured via a software-controlled Menu instead of physical controls on the transceiver. Once familiar with the Menu system, you will appreciate the versatility it offers. No longer is the number and complexity of features restricted by the physical controls and switches on the front panel.

MENU A/ MENU B

The transceiver has two menus. These menus are called Menu A and Menu B. The menus contain identical functions; however, each menu can be configured independently.

5

For example, you may enjoy two different kinds of operating activities but you like to configure the transceiver differently for each activity. Menu A could be configured with one set of transmit signal characteristics, DSP settings, programmable buttons, frequency steps, etc. Menu B could be configured completely differently. By switching from Menu A to Menu B, you could instantly change Menu configuration and button assignment to suit your current operating style. Or, two operators may share a single transceiver. By dedicating one Menu per operator, each would always enjoy the best configuration.

Note: The COM communication parameter setting in Menu No. 35 is shared by Menu A and Menu B.

MENU ACCESS

The following procedure explains how to check or change any of the Menu items.

- 1 Press **[MENU]**.
 - "MENU" appears.

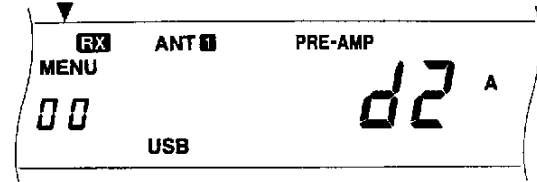

- 2 Press **[A/B]** to toggle Menu A or Menu B.
 - "A" or "B" appears to show which Menu is selected.
- 3 Turn the **MULT/CH** control to select the desired Menu No.
 - Each time you change the Menu No., you will see a scrolling message that briefly describes the current Menu No.
- 4 Press **[UP]**, **[DOWN]**, Mic **[UP]**, or Mic **[DWN]** to change the current selection for this Menu item.
- 5 Press **[MENU]** or **[CLR]** to exit Menu mode.

MENU CONFIGURATION

Group	Menu No.	Function	Selections	Default	Page Ref.
Operator Interface	00	Display brightness d1: maximum, d4: minimum	OFF/ d4/ d3/ d2/ d1	d2	49
	01	Beep output level 1: minimum, 9: maximum	OFF, 1 to 9	4	49
Encoder	02	Frequency step size for the [UP]/[DOWN] buttons in the 1 MHz step mode	100/ 500/ 1000 kHz	1000 kHz	29
	03	Frequency step size for the MULTI/CH control for SSB, CW, FSK, or AM mode	1/ 5/ 10 kHz	10 kHz	29
	04	Frequency step size for the MULTI/CH control for FM mode	1/ 5/ 10/ 12.5/ 20/ 25 kHz	10 kHz	29
	05	Rounds off VFO frequencies changed by using the MULTI/CH control	ON/ OFF	ON	29
	06	Frequency step size for the MULTI/CH control for AM mode in the AM broadcast band	9 kHz/ 10 kHz	See page reference	29
Memory Channel	07	Memory-VFO split operation	ON/ OFF	OFF	41
	08	Tunable (ON) or fixed (OFF) memory channel frequencies	ON/ OFF	OFF	41
Scan	09	Program scan hold	ON/ OFF	OFF	46
	10	Scan resume method	Time-operated/ Carrier-operated	Time-operated	47
Antenna Tuner	11	Antenna tuner operation while receiving signals	ON/ OFF	OFF	52
DSP	12	Time constant for the noise reduction 2 function	7.5/ 20 ms	20 ms	38
TX	13	TX filter bandwidth for SSB or AM mode	2.4/ 2.0 kHz	2.4 kHz	33
	14	TX equalizer OFF: flat, Hb: high boost, FP: formant pass, bb: bass boost, c: conventional	OFF/ Hb/ FP/ bb/ c	OFF	33
	15	Speech processor compression level	0 to 25 dB in steps of 5 dB	10 dB	32
	16	VOX gain 0: minimum, 9: maximum	0 to 9	4	31
	17	Microphone gain for FM mode L: low, H: high	L/ H	L	22
	18	Subaudible tone frequency for FM mode	See page reference	88.5 Hz	25
	19	Type of subaudible tone for FM mode B: burst, C: continuous	B/ C	See page reference	25
CW	20	CW RX pitch/ TX sidetone frequency	400 to 1000 Hz in steps of 50 Hz	800 Hz	21
	21	TX sidetone volume	OFF, 1 to 9	4	21
	22	Semi-automatic key ("Bug") function	ON/ OFF	OFF	35
DRU	23	Playback repeat	ON/ OFF	OFF	35, 53
	24	Interval between repeated playbacks	0 to 60 sec	10 sec	54
	25	Playback volume 1: minimum, 9: maximum	OFF, 1 to 9	4	54

5 MENU SETUP

Group	Menu No.	Function	Selections	Default	Page Ref.
CW	26	CW Auto weighting	ON/ OFF	ON	34
	27	CW Auto weighting reversed	ON/ OFF	OFF	34
	28	Keying priority over playback	ON/ OFF	OFF	35
Digital Operation	29	FSK shift	170/ 200/ 425/ 850 Hz	170 Hz	26
	30	Key-down polarity for FSK mode	ON (space)/ OFF (mark)	OFF	26
	31	Tone frequencies for FSK mode 2125: 2125 Hz mark, 1275: 1275 Hz mark	2125/ 1275 Hz	2125 Hz	26
	32	Filter bandwidth for digital operation (SSB mode only)	OFF/ 1200 bps/ 300 bps/ PSK	OFF	27
	33	AF input level for digital operation (excluding CW and FSK modes) 0: minimum, 2: maximum	0/ 1/ 2	2	27
	34	AF output level for digital operation 0: minimum, 9: maximum	0 to 9	4	27
Computer Interface	35	Communication parameters for COM connector Setting Transfer Rate (bps) Stop Bits 12-1 1200 1 24-1 2400 1 48-1 4800 1 48-2 4800 2 96-1 9600 1 192-1 19200 1 384-1 38400 1 576-1 57600 1	12-1/ 24-1/ 48-1/ 48-2/ 96-1/ 192-1/ 384-1/ 576-1 <i>Note: To reliably use the 38400 or 57600 bps transfer rates, the serial port of your computer must support these high-speed communications parameters.</i>	96-1	51
Data Transfer	36	Data transfer enable	ON/ OFF	OFF	50
	37	Method of receiving transferred data ON: Transfer to VFO OFF: Transfer to quick memory	ON/ OFF	OFF	50
TX	38	TX inhibit	ON/ OFF	OFF	33
	39	Linear amplifier control relay	ON/ OFF	OFF	61
Transverter	40	Enables/disables the 50, 144, or 430 MHz transverter function.	OFF/ 50/ 144/ 430 MHz	OFF	51
PF	41	Programs the [PF] button on the front panel.	See page reference	51 (Voice 1)	49
	42	Programs the Mic [PF1] button.	See page reference	64 ([A/B])	49
	43	Programs the Mic [PF2] button.	See page reference	62 ([SPLIT])	49
	44	Programs the Mic [PF3] button.	See page reference	65 ([M/V])	49
	45	Programs the Mic [PF4] button.	See page reference	50 (Monitor)	49
RX	46	IF filter bandwidth	OFF/ 1800/ 500/ 270 Hz	OFF	36

5

CROSS REFERENCE FOR MENU FUNCTIONS

Use this table arranged by subject to help you locate the function that you are interested in checking or changing. Consult "MENU CONFIGURATION" (page 17) for more detail on each function.

Function	Menu No.
AMPLIFIER	
Linear amplifier relay	39
ANTENNA TUNER (AT)	
RX enable/disable	11
BEEP FUNCTIONS	
Beep level	01
CW	
Auto weighting	26
Auto weighting reversed	27
Keying priority over playback	28
RX pitch	20
Semi-automatic key ("Bug") function	22
TX sidetone frequency	20
TX sidetone volume	21
DATA TRANSFER	
Transfer enable	36
Transfer method	37
DIGITAL OPERATION	
AF input (MCP/TNC TX)	33
AF output (MCP/TNC RX)	34
Filter bandwidth	32
DISPLAY	
Brightness	00
DRU-3A DIGITAL RECORDING SYSTEM (DRS)	
Playback repeat	23
Playback repeat interval	24
Playback volume	25
DIGITAL SIGNAL PROCESSING	
NR2 time constant	12
FM	
Microphone gain	17
Subtone frequency	18
Subtone type	19

Function	Menu No.
FREQUENCY STEPS	
MULTI/CH control (SSB, CW, FSK, AM)	03
MULTI/CH control (FM)	04
MULTI/CH control (AM and AM broadcast only)	06
MULTI/CH control (rounds off frequencies)	05
[UP]/[DOWN] buttons	02
FSK	
Polarity (space/mark)	30
Shift	29
Tone	31
MEMORY CHANNELS	
Memory-VFO split operation	07
Tunable/fix frequency	08
PROGRAMMABLE BUTTONS	
[PF] button	41
Mic [PF1] button	42
Mic [PF2] button	43
Mic [PF3] button	44
Mic [PF4] button	45
RECEIVE	
IF filter bandwidth	46
REAR PANEL	
COM communication parameters	35
SCAN	
Hold (Program Scan)	09
Resume (Time or Carrier)	10
SPEECH PROCESSOR	
Compression level	15
TRANSMIT	
Bandwidth (SSB or AM)	13
Equalizer	14
Inhibit	38
TRANSVERTER	
Enable/disable	40
VOICE-OPERATED TRANSMIT (VOX)	
Gain	16

5

BASIC COMMUNICATING

SSB TRANSMISSION

SSB is now the most commonly-used mode on the HF Amateur bands. Compared with other voice modes, SSB requires a narrow bandwidth for communications. SSB also allows long distance communication with minimum transmit power. These reasons, combined with the fact that modern Amateur transceivers deliver reasonably good audio quality, make SSB the mode that most prefer on HF.

Refer, if necessary, to "OPERATING BASICS" beginning on page 13 for receiving details.

- 1 Select the operating frequency.
- 2 Press **[LSB/USB]** to select either upper or lower sideband mode.
 - "LSB" or "USB" appears to show which sideband is selected.



- 3 Press **[MIC]** to activate the Microphone Gain Setting function.
 - The current gain level appears .

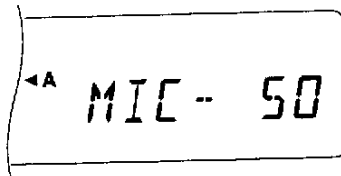

- 4 Press and hold down Mic **[PTT]**, or press **[SEND]**.
 - "RX" disappears and "TX" appears.
 - Refer to "VOX" {page 31} for information on automatic TX/RX switching.
- 5 Speak into the microphone and adjust the **MULT/CH** control so that the ALC meter reflects according to your voice level.
 - Speak in a normal tone and level of voice. Speaking too close to the microphone, or too loudly, may increase distortion and reduce intelligibility.
 - You may want to use the Speech Processor. Refer to "SPEECH PROCESSOR" {page 32} for details.

- 6 Release Mic **[PTT]**, or press **[SEND]** again, to return to the receive mode.
 - "TX" disappears and "RX" appears.
- 7 Press **[MIC]** again to quit the Microphone Gain Setting function.

Refer to "COMMUNICATING AIDS" beginning on page 29 for information about additional useful functions for operating.

CW TRANSMISSION

CW operators know that this mode is a reliable method of communicating under the worst conditions. Although it's true that newer digital modes rival CW as being equally as useful in poor conditions, these modes do not have the long history of service yet nor the simplicity that CW can have.

This transceiver has a built-in electronic keyer that supports a variety of functions. For details on using these functions, refer to "ELECTRONIC KEYS" (page 34).

Refer, if necessary, to "OPERATING BASICS" beginning on page 13 for receiving details.

- 1 Select the operating frequency.
- 2 Press [CW/FSK] to select CW mode.
 - "CW" appears.

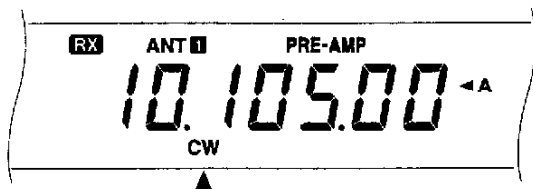

- To tune in another station so your transceiver is precisely on their frequency, use Auto Zero-beat. Refer to "AUTO ZERO-BEAT".
- If you wish, you can press [REV] to switch receive from the default upper sideband to the lower sideband. "R" will appear.

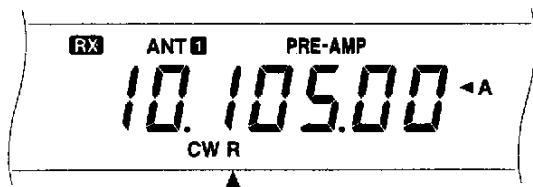

- 3 Press [SEND].
 - "RX" disappears and "TX" appears.
 - No transmit carrier level adjustment is necessary.
 - Refer to "CW BREAK-IN" (page 34) for information on automatic TX/RX switching.
- 4 Begin sending.
 - As you transmit, you should be hearing a sidetone that lets you monitor your own sending. Refer to "TX SIDETONE/ RX PITCH FREQUENCY".
- 5 Press [SEND] again to return to the receive mode.
 - "TX" disappears and "RX" appears.

Note: Auto Zero-beating may fail if there are other interfering signals on frequency.

Refer to "COMMUNICATING AIDS" beginning on page 29 for information about additional useful functions for operating.

AUTO ZERO-BEAT

Use Auto Zero-beat before transmitting whenever you need to tune in a CW station. Auto Zero-beat automatically and exactly matches your transmit frequency with the station that you are receiving. Neglecting to do this will reduce your chances for being heard by the other station.

- 1 Press [CW TUNE] to start Auto Zero-beat.
 - "CW TUNE" appears.

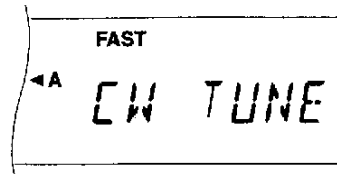

- Your transmit frequency is automatically changed so that the pitch of the received signal exactly matches the TX sidetone/ RX pitch frequency that you have set in your transceiver Menu configuration. Refer to "TX SIDETONE/ RX PITCH FREQUENCY" below for further information on that frequency.
 - When matching is completed, "CW TUNE" disappears.
 - If matching is unsuccessful, the previous frequency is restored.
- 2 To interrupt Auto Zero-beat, press [CW TUNE] or [CLR].

Note:

- You cannot start Auto Zero-beat if you have selected 1.0 kHz or 2.0 kHz for the DSP filter bandwidth.
- When using Auto Zero-beat, the matching error is within ± 50 Hz in most cases.
- Auto Zero-beat may fail if the keying speed of the target station is too slow.

TX SIDETONE/ RX PITCH FREQUENCY

The transmit sidetone is the monitor tone you hear from your transceiver as you send CW. It is necessary so you can hear what you are transmitting. It is also useful for checking that your key contacts are closing, the keyer is functioning, or for sending practice without putting a signal on the air.

Receive pitch refers to the frequency of the CW note that you hear after tuning your receiver for maximum receive signal strength.

On this transceiver, the frequency of the sidetone and receive pitch are equal and selectable. Use Menu No. 20 to select the frequency that is most comfortable for you.

To change the volume of the TX sidetone, use Menu No. 21. The selections include OFF and 1 to 9. The default is 4.

Note: The position of the AF control does not affect the volume of the TX sidetone.

6 BASIC COMMUNICATING

FM TRANSMISSION

FM operation on HF frequencies solves the problem of how to have long distance voice communication with the finest audio quality. When combined with the full-quieting aspect of FM signals that suppress background noise on the frequency, FM can be the best method for maintaining regular schedules with friends.

Refer, if necessary, to "OPERATING BASICS" beginning on page 13 for receiving details.

- 1 Select the operating frequency.
- 2 Press **[FM/AM]** to select FM mode.
 - "FM" appears.

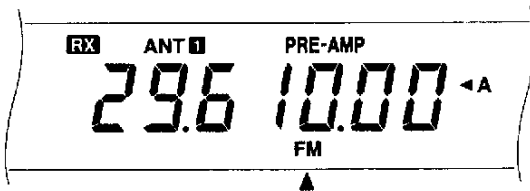

- 3 Press and hold down Mic **[PTT]**, or press **[SEND]**.
 - "RX" disappears and "TX" appears.
 - Refer to "VOX" {page 31} for information on automatic TX/RX switching.
- 4 Speak into the microphone in a normal tone and level of voice.
 - Speaking too close to the microphone, or too loudly, may increase distortion and reduce intelligibility.
 - Microphone gain can be switched between low and high for FM using Menu No. 17. Low is usually appropriate; however, select high if reports from other stations indicate that your audio is weak. The **MULT/CH** control has no effect in FM mode.

TX DEVIATION SELECTION

Select wide band or narrow band TX deviation depending on whether the other station is using wide band or narrow band RX deviation. This selection is crucial to avoid audio distortion or insufficient intelligibility that the other station will encounter.

- 1 Press **[FM/AM]** to select FM mode.
- 2 Press **[FILTER]**.
 - The current filter selection appears.

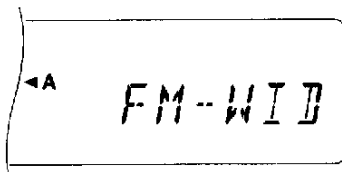

- 3 Turn the **MULT/CH** control to select Wide ("FM-WID") or Narrow ("FM-NAR").
- 4 Press **[FILTER]** to complete the setting.

Refer to "COMMUNICATING AIDS" beginning on page 29 for additional information about useful functions for operating.

AM TRANSMISSION

Each mode used on the HF Amateur bands has its own advantages. Although long distance DX contacts may be less common while using AM, the superior audio quality characteristic of AM operation is one reason why some prefer this mode.

When looking for others using AM, check the following frequencies first:

- 3885, 7290, 14286, 21390, and 29000-29200 kHz

Refer, if necessary, to "OPERATING BASICS" beginning on page 13 for receiving details.

- 1 Select the operating frequency.
- 2 Press **[FM/AM]** to select AM mode.
 - "AM" appears.

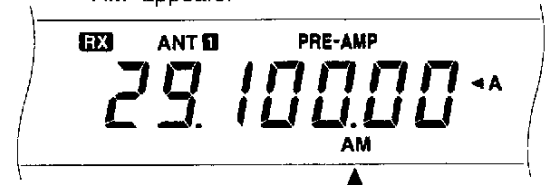

- 3 Press **[MIC]** to activate the Microphone Gain Setting function.
 - The current gain level appears.
- 4 Press and hold down Mic **[PTT]**, or press **[SEND]**.
 - "RX" disappears and "TX" appears.
 - No transmit carrier level adjustment is necessary.
 - Refer to "VOX" {page 31} for information on automatic TX/RX switching.
- 5 Speak into the microphone and adjust the **MULT/CH** control so that the calibrated power meter slightly reflects according to your voice level.
 - Speak in a normal tone and level of voice. Speaking too close to the microphone, or too loudly, may increase distortion and reduce intelligibility.
 - You may want to use the Speech Processor. Refer to "SPEECH PROCESSOR" {page 32} for details.
- 6 Release Mic **[PTT]**, or press **[SEND]** again, to return to the receive mode.
 - "TX" disappears and "RX" appears.
- 7 Press **[MIC]** to quit the Microphone Gain Setting function.

Refer to "COMMUNICATING AIDS" beginning on page 29 for information about additional useful functions for operating.

SPLIT-FREQUENCY OPERATION

Usually you can communicate with other stations using the same frequency for receiving and transmitting. In this case, you select only one frequency on either VFO A or VFO B. However, there are cases where you must select one frequency for receiving and another frequency for transmitting. To do this requires two VFOs. This is referred to as “split-frequency operation”. One typical case that requires this type of operation is described below.

When a rare or desirable DX station is heard, he or she may immediately get many responses, all at the same time. Often such a station is lost under the noise and confusion of many calling stations. If you find that you are suddenly being called as that rare or desirable station, it is your responsibility to control the situation. You may announce that you will be “listening up 5 (kHz, from your present transmit frequency)”, or “listening down between 5 and 10 (kHz)”.

- 1 Press [**A/B**] to select VFO A or VFO B.
 - “◀A” or “◀B” appears to show which VFO is selected.
- 2 Select the operating frequency.
 - The frequency selected here will be used for transmitting.
- 3 Press [**A/B**] to select the other VFO.
- 4 Select the operating frequency.
 - The frequency selected on this VFO will be used for receiving.
- 5 Press [**SPLIT**].
 - “SPLIT” appears.

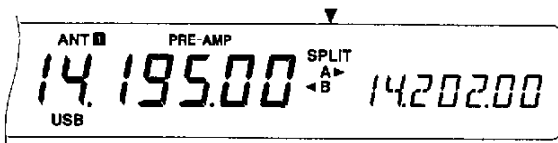

- Pressing [**A/B**] reverses the receive frequency and the transmit frequency.
- 6 Press [**SPLIT**] to quit split-frequency operation.
 - “SPLIT” disappears.

If you access Menu No. 07 and select ON, you can recall a memory channel to use for either receiving or transmitting. For more information, refer to “Memory-VFO Split Operation” {page 41} under “MEMORY FEATURES”.

Note: If you configure split frequencies using two different bands to perform CW operation, select Semi Break-in.

TF-SET (TRANSMIT FREQUENCY SET)

TF-SET allows you to temporarily switch your transmit frequency and receive frequency. Canceling this function immediately restores the original transmit and receive frequencies. By activating TF-SET, you can listen on your transmit frequency, and change it while listening. This allows you to check if the newly selected transmit frequency is free of interference.

- 1 Activate split-frequency operation as explained in the previous section.
- 2 Press and hold [**TF-SET**]. While holding down [**TF-SET**], change the operating frequency by turning the **Tuning** control or pressing Mic [**UP**]/[**DOWN**].
 - The transceiver receives on the frequency that you select, but the frequency shown on the sub-display stays unchanged.
- 3 Release [**TF-SET**].
 - You are now receiving again on your original receive frequency.

Successfully contacting a DX station in a pileup often depends on making a well-timed call on a clear frequency. The best way to know if your intended transmit frequency is clear is to use TF-SET. Switch your receive frequency and transmit frequency by using TF-SET and listen. You soon will learn the rhythm of the DX station and the pileup.

Use the information to select a relatively clear transmit frequency and to transmit at the exact instant when the DX station is listening but the majority of the group aren't transmitting. The more proficient you become at using this function, the more DX you will contact.

Note:

- ◆ If you press [**F.LOCK**] before using TF-SET, pressing an incorrect button by mistake will not change the original receive frequency.
- ◆ TF-SET is disabled while transmitting.
- ◆ If you recalled a memory channel (excluding CH 90 to 99), you must set Menu No. 08 to ON to use TF-SET to change the frequency of the memory channel.
- ◆ An RIT frequency shift is not added; however, an XIT frequency shift is added to the transmit frequency.
- ◆ TF-SET is also enabled while operating with the same TX/RX frequency (non-split).



7 SPECIALIZED COMMUNICATING

FM REPEATER OPERATION

Most Amateur radio voice repeaters use a separate receive and transmit frequency. The transmit frequency may be higher or lower than the receive frequency. In addition, some repeaters may require the transceiver to transmit a subtone before the repeater can be used.

Compared to simplex communication, you can usually transmit over much greater distances by using a repeater. Repeaters are typically located on a mountain top or other elevated location. Often they operate at higher ERP (Effective Radiated Power) than a typical station. This combination of elevation and high ERP allows communications over considerable distances.

HF repeaters operate only in the 29 MHz FM sub-band. This special service combines the advantages of FM operation, good fidelity with noise and interference immunity, with the excitement of HF DX (long distance) communications. Even on a quiet day, 10 meter FM provides reliable around-town communications with the potential for sudden DX from across the country or around the world.

7

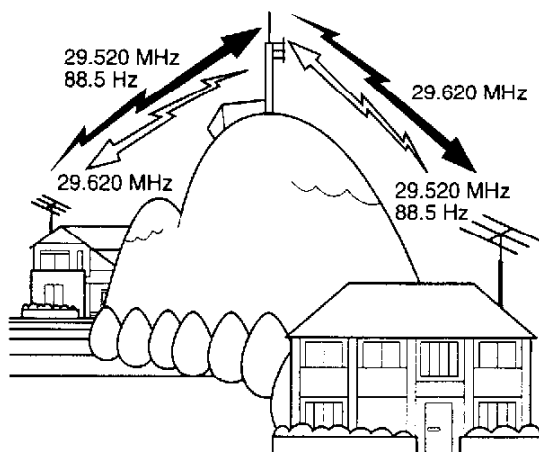

ARRL 10-METER BAND PLAN

Frequency Range (kHz)	Mode/Activity
28000~28070	CW
28070~28150	RTTY
28120~28189	Packet
28190~28300	Beacons
28300~29300 (29000~29200)	Phone (AM)
29300~29510	Satellite downlinks
29510~29590	Repeater inputs ¹
29600	FM simplex calling
29610~29700	Repeater outputs ¹

¹ Repeater frequency pairs (input/output):
29520/29620, 29540/29640, 29560/29660,
29580/29680

- Press **[A/B]** to select VFO A or VFO B.
 - “◀A” or “◀B” appears to show which VFO is selected.
- Select the operating frequency.
 - The frequency selected here will be used for transmitting.
- Press **[FM/AM]** to select FM mode.
 - “FM” appears.
- Press **[A/B]** to select the other VFO.
 - To copy the frequency that you select in step 2 to another VFO, press **[A=B]** before pressing **[A/B]**.
- Select the operating frequency.
 - The frequency selected on this VFO will be used for receiving.
- Press **[FM/AM]** to select FM mode.
- Press **[SPLIT]**.
 - “SPLIT” appears.
 - Pressing **[A/B]** reverses the receive frequency and the transmit frequency.
- Select the subtone frequency via Menu Nos. 18 and 19.
 - See “SELECTING SUBTONE FREQUENCY” and “CONTINUOUS OR BURST SUBTONES?” for more details on the subtone.
- Press **[AGC/TONE]** to activate the Subtone function.
 - “T” appears.

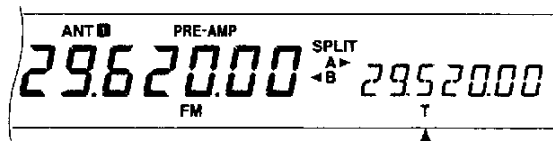

- To quit the Subtone function, press **[AGC/TONE]** twice.
- Press **[SPLIT]** to quit split-frequency operation.
 - “SPLIT” disappears.

If you access Menu No. 07 and select ON, you can recall a memory channel to use for either receiving or transmitting. For more information, refer to “Memory-VFO Split Operation” (page 41) under “MEMORY FEATURES”.

The data that you select in steps 1 to 9 except for subtone duration can be stored in memory. Refer to “Split-Frequency Channels” (page 40).

Note:

- When operating through a repeater, over deviation caused by speaking too loudly into the microphone can cause your signal to “talk-off” (break up) through the repeater.
- To check the subtone frequency stored in a memory channel, recall the desired memory channel, and access Menu No. 18.

SELECTING SUBTONE FREQUENCY

Some 10-meter FM repeaters require the transceiver to transmit a subtone, to prevent other repeaters on the same frequency from locking each other up. The required subtone frequency depends on the repeater you are accessing. In Europe, a 1750 Hz tone is generally used to access repeaters.

Select the subtone frequency you require via Menu No. 18. The default is 88.5 Hz. The available choices are shown in the table below.

No.	Freq. (Hz)	No.	Freq. (Hz)	No.	Freq. (Hz)	No.	Freq. (Hz)
01	67.0	11	97.4	21	136.5	31	192.8
02	71.9	12	100.0	22	141.3	32	203.5
03	74.4	13	103.5	23	146.2	33	210.7
04	77.0	14	107.2	24	151.4	34	218.1
05	79.7	15	110.9	25	156.7	35	225.7
06	82.5	16	114.8	26	162.2	36	233.6
07	85.4	17	118.8	27	167.9	37	241.8
08	88.5	18	123.0	28	173.8	38	250.3
09	91.5	19	127.3	29	179.9	39	1750
10	94.8	20	131.8	30	186.2		

Note: Use Nos. 01 to 39 shown in the table above when selecting subtone frequencies via Computer Control (page 51).

CONTINUOUS OR BURST SUBTONES?

In addition to selecting the frequency of the subtone, you must choose the correct subtone duration. The Continuous selection continuously sends the subtone as long as the transceiver is transmitting. The Burst selection sends a 500 ms subtone burst each time the transceiver begins transmitting.

Select either Continuous or Burst via Menu No. 19. The default is Continuous except on some European versions.

FM CTCSS OPERATION

CTCSS is the abbreviation for Continuous Tone Coded Squelch System. CTCSS uses subaudible tone frequencies. While you are transmitting, a subtone that you select is superimposed on your transmit signal.

Suppose that only stations "A", "B", and "C" are programmed with the same subtone frequency. When "A" calls, the squelch on only "B" and "C" opens. So you can choose which stations will receive your transmissions.

- Press **[A/B]** to select VFO A or VFO B.
 - "◀A" or "◀B" appears to show which VFO is selected.
- Select the desired subtone frequency via Menu No. 18.
- Select the operating frequency.
- Press **[FM/AM]** to select FM mode.
 - "FM" appears.
- Turn the **SQL** control to adjust squelch.
- Repeatedly press **[AGC/TONE]** until "CTCSS" appears.

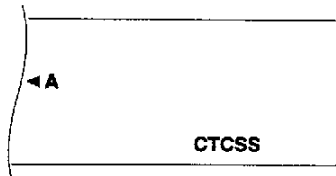

- To quit CTCSS, press **[AGC/TONE]** again.

7 When you are called:

The squelch in your transceiver opens only when the selected subtone is received.

When you make a call:

Press and hold Mic **[PTT]**, or press **[SEND]**.

- The selected subtone is superimposed on your transmitted signal.

Note:

- When using split-frequency operation, select FM mode on both VFOs to use CTCSS.
- While selecting 1750 Hz subtone, you cannot switch ON the CTCSS.

7 SPECIALIZED COMMUNICATING

DIGITAL OPERATION

Since Multimode Communications Processors (MCP) have become popular, many Amateurs enjoy operating using a number of digital modes. The power and variety of Amateur radio increased greatly with the development of MCP that can use your transceiver as the communications link.

For example, it's possible to take advantage of the camaraderie found on RTTY, then move to Packet to access an RBBS (Radio Bulletin Board System) to download a recent shareware program you've heard about, and then move again to AMTOR or PACTOR to deposit mail in a regional mailbox for forwarding. After that, you may switch to G-TOR™ or Clover for a lightning fast file transfer with a friend.

RTTY (FREQUENCY SHIFT KEYING)

Radioteletype operation uses frequency shift keying (FSK) and the 5-bit Baudot code or the 7-bit ASCII code to transmit information.

Consult "RTTY" (page 61) under "CONNECTING PERIPHERAL EQUIPMENT" if you need installation information.

7

- 1 Select the FSK shift via Menu No. 29.
 - FSK shift is the difference in frequencies between mark and space.
 - The 170 Hz default is used on the Amateur bands.
- 2 Access Menu No. 30, and select either "ON" (space) or "OFF" (mark) to be transmitted when keying down.
 - The default is "OFF" (mark).
- 3 Access Menu No. 31, and select high tone (2125 Hz) or low tone (1275 Hz) for mark.
 - The high tone (default) is commonly used nowadays.
- 4 Select the operating frequency.
- 5 Press **[CW/FSK]** to select FSK.
 - "FSK" appears.

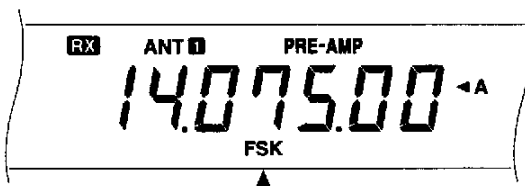

- 6 If necessary to be compatible with the station you want to contact, press **[REV]** to reverse the transceiver to the upper sideband.
 - "R" appears beside "FSK".



- Traditionally, the lower sideband is used for FSK operation.
 - Press **[REV]** again if you want to return to the lower sideband.
- 7 Following the instructions provided with your MCP or RTTY equipment, enter the key sequence at your RTTY keyboard to select the transmit mode.
 - "RX" disappears and "TX" appears.
 - You may instead press **[SEND]** to manually select the transmit mode.
 - 8 Begin sending data from the keyboard.
 - No transmit carrier or AF input level adjustment is necessary.
 - Use Menu No. 34 to select the appropriate AF output level. The **AF** control cannot be used for this adjustment.
 - 9 When finished transmitting, enter the key sequence from the keyboard to return to the receive mode.
 - "TX" disappears and "RX" appears.
 - If you pressed **[SEND]** in step 7, press **[SEND]** again.

RTTY FREQUENCIES

IARU Region 1 (Europe/Africa) Frequency (kHz)	U.S.A./Canada Frequency (kHz)
1838~1842	1800~1840
3580~3620	3605~3645 (DX: 3590)
7035~7045	7080~7100 (DX: 7040)
10140~10150	10140~10150
14080~14099.5	14070~14099.5
18101~18109	18100~18110
21080~21120	21070~21100
24920~24929	24920~24930
28050~28150	28070~28150

AMTOR/ PACKET/ PACTOR/ G-TOR™/ CLOVER

Due to their error-handling capability and speed of transmission, these modes are more efficient than earlier forms of digital communication by machine. In the case of G-TOR™, it was developed specifically to handle the adverse conditions of communicating across the solar system with spacecraft during their missions.

Mode	Meaning
AMTOR	AMateur Teleprinting Over Radio
Packet	Packetized data used per AX.25 protocol
PacTOR	Packet Teleprinting Over Radio
G-TOR™	Golay-coded Teleprinting Over Radio
Clover	Characteristic shape of an accurately tuned signal as viewed on a monitor.

On most HF bands, audio frequency shift keying (AFSK) is used. This method of modulation uses audio tones therefore either the LSB or USB mode should be selected. Traditionally, LSB is used similar to RTTY with the exception of AMTOR which is normally operated using USB.

In some countries, the licensing authorities permit F2 operation on some frequencies in the 10 meter band. For this type of operation, select the FM mode.

Consult "MCP AND TNC" {page 62} under "CONNECTING PERIPHERAL EQUIPMENT" if you need installation information.

Note: When using the SSB mode for digital operation, use a fast AGC setting and switch OFF your Speech Processor. Remember to set Menu No. 32 to OFF for voice operation since the filters available are too narrow for voice. If the setting in Menu No. 32 is not OFF, "FSK" is visible in addition to "LSB" or "USB".

- Select the appropriate filter bandwidth via Menu No. 32.
 - The default is OFF.
- Select the operating frequency.
- Press [**LSB/USB**] to select LSB or USB.
 - If you selected one of the filters in step 1 (not OFF), "FSK" appears with "LSB" or "USB".
 - For F2 operation, select FM by pressing [**FM/AM**]. The filter selected via Menu No. 32 cannot be used for FM.
- Following the instructions provided with your TNC or MCP, enter the calibrate mode so you can generate a mark condition.
 - "RX" disappears and "TX" appears.
- Use Menu No. 33 to select the appropriate AF input level.
 - Select a low input level so long as the ALC meter reflects.
- Exit the calibrate mode.
 - "TX" disappears and "RX" appears.

- Use Menu No. 34 to select the appropriate AF output level.
 - The **AF** control cannot be used for this adjustment.
- Send commands and data.
 - The transceiver will briefly transmit each time it sends your commands and data, or when it acknowledges transmissions from other stations.

The data rates and types of modulation used for HF Packet operation are shown below.

Mode	Data Rate	Modulation Type
USB & LSB	300 bps (AFSK)	F1
USB & LSB	1200 bps (PSK)	F1
FM	1200 bps (AFSK)	F2

Note: In some countries, F2 modulation at 1200 bps may be used on the 10-meter band. Consult your national Amateur radio organization to obtain band plans that specify where in each band various modes are used.

PACKET FREQUENCIES

IARU Region 1 (Europe/Africa) Frequency (kHz)	U.S.A./Canada Frequency (kHz)
—	1800~1830
3590~3600	3620~3635
Digital band	7080~7100
Digital band	10140~10150
14089~14099, 14101~14112	14095~14099.5
Digital band	18105~18110
21100~21120	21090~21100
Digital band	—
28120~28150, 29200~29300	28120~28189
—	50600~50780

AMTOR activity can be found on or near 14075 and 3637.5 kHz. These would also be good starting places when searching for PacTOR, G-TOR™, or Clover stations.

SLOW SCAN TV/ FACSIMILE

SSTV is now increasing in popularity as a result of the capability of computers. Using this technique, you can transmit and receive still monochrome or full-color images. Instead of trying to describe your station, just showing it is much faster. To do this, you require a scan converter to translate your video images into audio signals that can be fed into your transceiver. Or, to begin more simply, you can use only your computer with readily available software to perform this task. A TV set and a video camera that you may already own will also be useful tools.

SSTV FREQUENCIES

IARU Region 1 (Europe/Africa) Frequency (kHz)	U. S. A./Canada Frequency (kHz)
3730-3740	3845
7035-7045	7171
14225-14235	14230
21335-21345	21340
28675-28685	28680

7

The high resolution that is possible using facsimile (fax) can allow you to exchange more detailed graphics than SSTV allows. Due to the longer transmission times required for fax, it's best to use this mode when band conditions are stable with strong signals.

Popular fax frequencies include the following:

- 7245, 14245, 21345 (Intern. Net), 28945 kHz

Operation on SSTV or fax mainly involves learning the functionality of your computer application or accessory hardware that supports these modes. Consult the documentation that comes with your software or accessory equipment.

Note: When operating either SSTV or fax, use a fast AGC setting and switch OFF your Speech Processor for best results.

SATELLITE OPERATION

Though not as common as VHF/UHF satellite operation, HF satellite operation is possible depending on which satellites are currently in orbit around the Earth. When HF propagation is poor, satellite operation can provide an incentive to get back on the air. Since this communications mode is so reliable, you may discover you actually prefer satellite operation over the hunt-and-miss method of communicating via the ionosphere.

An example of a Mode K satellite that uses uplink and downlink HF frequencies is the Radio Sputnik 12 (RS-12). Launched in the early 1990s, this satellite is in a low Earth orbit and provides brief windows of opportunity for use as it passes quickly over your location. The satellite accepts SSB or CW signals on the 15 meter band and outputs them on 10 meters.

This transceiver can also be used with Mode A satellites, if you have an SSB/CW VHF transceiver. Mode A satellites use a VHF uplink and an HF downlink.

If you're interested in pursuing satellite operation, contact AMSAT (Radio Amateur Satellite Corporation) directly or via their internet Home page. This group of satellite operators, located all over the world, support the construction and operation of satellites. AMSAT can provide you with the latest information regarding Mode K and Mode A satellites that are currently in orbit.

RECEIVING

SELECTING YOUR FREQUENCY

In addition to turning the **Tuning** control or pressing Mic **[UP]/[DOWN]**, there are several other ways to select your frequency. This section describes additional methods of frequency selection that may save you effort and time.

■ Direct Frequency Entry

When the desired frequency is far removed from the current frequency, directly entering a frequency from the numeric keypad can be the fastest method.

1 Press **[ENT]**.

- “- - - - -” appears.

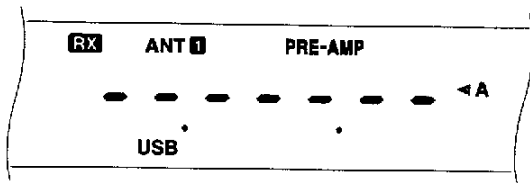

2 Press numeric buttons **[0]** to **[9]** to enter the frequency you desire.

- Pressing **[ENT]** fills the remaining un-entered digits with 0 and completes entry.
- To select 1.85 MHz for example, press **[0]** for the 10 MHz digit (first digit), because you can also select 18.5 MHz on this transceiver.
- Pressing **[CLR]** cancels entry and restores the previous frequency.

Note:

- ◆ Some digits cannot be entered for the 10 MHz digit (first digit). Pressing one of those digits will cause that digit to be entered in the 1 MHz position.
- ◆ When the 10 Hz digit (last digit) is entered, the digit 0 is entered automatically for the 1 Hz digit, and frequency entry is completed. The 1 Hz digit is not displayed.
- ◆ Attempting to enter a frequency that is outside the selectable frequency range causes an alarm to be generated. The entered frequency is rejected.
- ◆ When an entered frequency is accepted, RIT and XIT are switched OFF, but the RIT or XIT frequency is not changed.
- ◆ After recalling memory channels 90 to 99 that have Start and End frequencies stored, the receive frequency can be changed by using Direct Frequency Entry within the programmed range.

■ Using 1 MHz Steps

Pressing **[UP]/[DOWN]** on the front panel changes Amateur bands. You can also use **[UP]/[DOWN]** to change operating frequencies in steps of 1 MHz.

1 Press **[1MHz]**.

- “1MHz” appears.

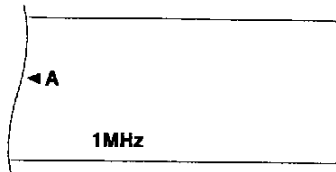

2 Press **[UP]** or **[DOWN]**.

- Holding down either button causes the function to repeat.

3 To restore the original function, press **[1MHz]** again.

- “1MHz” disappears.

If you prefer 100 kHz or 500 kHz steps instead of 1 MHz, use Menu No. 02. The default is 1 MHz.

■ Quick Changes

To move up or down in frequency quickly, use the **MULT/CH** control. Turning this control changes the operating frequency in 10 kHz steps.

- If you want to change the frequency step size, use Menu Nos. 03 and 04. Select 1 kHz, 5 kHz, 10 kHz, 12.5 kHz, 20 kHz, or 25 kHz for FM, and select 1 kHz, 5 kHz, or 10 kHz for the other modes. The default for both Menu numbers is 10 kHz.
- When changing the operating frequency by using the **MULT/CH** control, frequencies are rounded such that new frequencies are multiples of the frequency step size. To cancel this function, access Menu No. 05 and select OFF.
- Within the AM broadcast band, the step size automatically defaults to 9 kHz (U.S.A./Canada versions: 10 kHz) for AM mode. This step size can be switched between 9 kHz and 10 kHz via Menu No. 06.

8 COMMUNICATING AIDS

■ Fine Tuning

Usually, turning the **Tuning** control changes the frequency in steps of 10 Hz for SSB, CW, and FSK modes, and 100 Hz for FM and AM modes. However, you can also change the step size to 1 Hz for SSB, CW, and FSK modes, and to 10 Hz for FM and AM modes.

- 1 Press **[FINE]**.

- "FINE" appears.

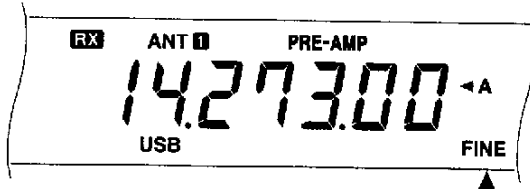

- 2 Turn the **Tuning** control to select the exact frequency.
- 3 To cancel the function, press **[FINE]** again.
 - "FINE" disappears.

■ Equalizing VFO Frequencies (A=B)

This function allows you to copy the frequency and modulation mode of the active VFO to the inactive VFO.

- 1 Select the frequency and mode on VFO A or VFO B.
- 2 Press **[A=B]**.
 - The frequency and mode selected in step 1 are copied to the inactive VFO.
- 3 Press **[A/B]** if you want to confirm that the frequency was copied.

RIT (RECEIVE INCREMENTAL TUNING)

RIT provides the ability to change your receive frequency by ± 9.99 kHz in steps of 10 Hz without changing your transmit frequency. If the Fine Tuning (**[FINE]**) function is ON, the step size is 1 Hz. RIT works equally well with all modulation modes and while using VFO mode or Memory Recall mode.

- 1 Press **[RIT]**.
 - "RIT" and the RIT offset appear.



- 2 If required, press **[CLEAR]** to reset the RIT offset to 0.

- 3 Turn the **RIT/XIT** control to change your receive frequency.

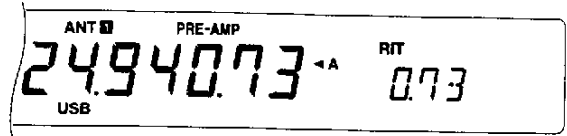

- 4 To cancel RIT, press **[RIT]**.

- The receive frequency is returned to the frequency that was selected prior to step 1.

Note:

- ◆ When using Memory Recall, RIT only functions with a memory that contains stored data.
- ◆ The frequency shift set by the RIT/XIT control is also used by the XIT function. Therefore, changing or clearing the RIT offset also affects the XIT offset.

AGC (AUTOMATIC GAIN CONTROL)

When using modes other than FM, AGC selects the time constant for the automatic gain control circuit.

Selecting a slow time constant will cause the receiver gain and S-meter readings to react slowly to large input changes. A fast time constant causes the receiver gain and the S-meter to react quickly to changes in the input signal. A fast AGC setting is particularly useful in the following situations:

- Tuning rapidly
- Receiving weak signals
- Receiving high-speed CW

The default time constant is slow for SSB, fast for CW, fast for FSK, and slow for AM.

- 1 Assume that USB is currently selected.
- 2 Press **[AGC/TONE]**.

- "FAST" appears and shows that a fast time constant is selected.

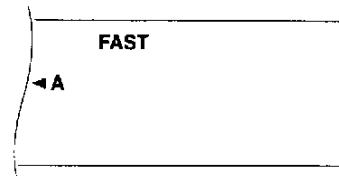

- 3 To select a slow time constant, press **[AGC/TONE]** again.

TRANSMITTING

VOX (VOICE-OPERATED TRANSMIT)

VOX eliminates the necessity of manually switching to the transmit mode each time you want to transmit. The transceiver automatically switches to transmit when the VOX circuitry senses that you have begun speaking into the microphone.

When using VOX, develop the habit of pausing between thoughts to let the transceiver drop back to receive briefly. You will then hear if anybody wants to interrupt, plus you will have a short period to gather your thoughts before speaking again. Your listener will appreciate your consideration as well as respect your more articulate conversation.

VOX can be switched ON and OFF independently for CW and the other modes excluding FSK.

Press **[VOX]** to toggle VOX between ON and OFF.

- "VOX" appears when the function is ON.

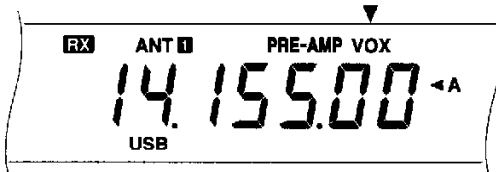

Microphone Input Level

To enjoy the VOX function, take time to set the gain of the VOX circuit to the correct level. This level controls the capability of the VOX circuit to detect the presence or absence of your voice. When using CW mode, this level cannot be adjusted.

- 1 Select SSB, FM, or AM mode.
- 2 Switch the VOX function ON.
- 3 Access Menu No. 16.
- 4 While speaking into your microphone using your normal level of voice, select different settings (default is 4) until the transceiver reliably switches to transmit each time you speak.
 - The selectable range is 0 to 9.
 - The final selection should not allow background noises near your operating position to falsely switch the transceiver from receive to transmit.

Note: Menu No. 16 is configurable even if VOX is OFF or while you are transmitting.

Delay Time

If the transceiver immediately returns to receive too quickly after you stop speaking, your final word may not be transmitted. To avoid this, select the appropriate delay time that allows all of your words to be transmitted without an overly long delay after you stop speaking.

- 1 Select SSB, FM, or AM mode.
- 2 Switch the VOX function ON.
- 3 Press **[DELAY]**.
 - The current setting appears. The default is 50.

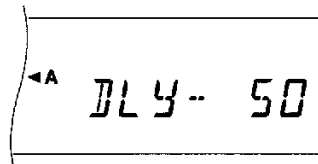

- 4 While speaking into your microphone using your normal level of voice, adjust the **MULT/CH** control such that the transceiver switches to receive a brief time after you stop talking.
 - The selectable range is 5 to 100 (150 ms to 3000 ms) in steps of 5, and OFF.
- 5 Press **[DELAY]** again.

8 COMMUNICATING AIDS

SPEECH PROCESSOR

The Speech Processor levels large fluctuations in your voice while you speak. When using SSB, FM, or AM mode, this leveling action effectively raises the average transmit output power, resulting in a more understandable signal. The amount of voice compression is fully adjustable. You will notice that using the Speech Processor makes it easier to be heard by distant stations.

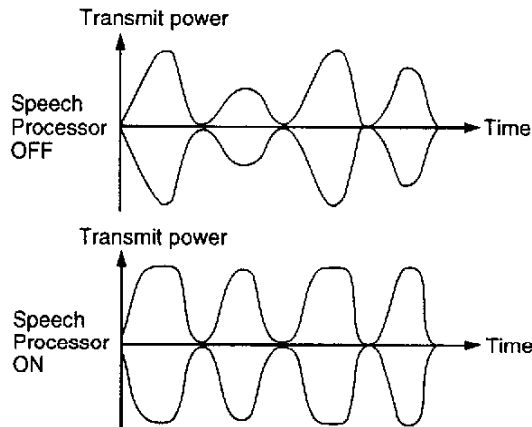

- 1 Select SSB, FM, or AM mode.
- 2 Press **[PROC]** to switch the Speech Processor ON.
 - “PROC” appears. The SWR meter disappears, and the COMP meter appears.

8

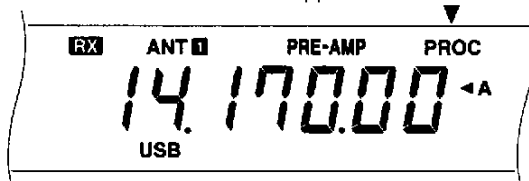

- 3 Access Menu No. 15 and select the desired level of compression.
 - Selectable range is 0 dB to 25 dB in steps of 5 dB. The recommended selection and default is 10 dB.
 - Using higher compression will not improve your signal clarity or apparent signal strength. Excessively compressed signals are more difficult to understand due to distortion and are less pleasant to hear than signals with less compression.
- 4 To switch the Speech Processor OFF, press **[PROC]** again.
 - “PROC” disappears. The COMP meter disappears, and the SWR meter appears.

XIT (TRANSMIT INCREMENTAL TUNING)

Similar to RIT, XIT provides the ability to change your transmit frequency by ± 9.99 kHz in steps of 10 Hz without changing your receive frequency. If the Fine Tuning (**[FINE]**) function is ON, the step size is 1 Hz.

- 1 Press **[XIT]**.
 - “XIT” and the XIT offset appear.



- 2 If required, press **[CLEAR]** to reset the XIT offset to 0.
- 3 Turn the **RIT/XIT** control to change your transmit frequency.



- 4 To cancel XIT, press **[XIT]**.
 - The transmit frequency is returned to the frequency that was selected prior to step 1.

Note: The frequency shift set by the RIT/XIT control is also used by the RIT function. Therefore, changing or clearing the XIT offset also affects the RIT offset.

CUSTOMIZING TRANSMIT SIGNAL CHARACTERISTICS

The quality of your transmitted signal is important regardless of which on-the-air activity you pursue. However, it's easy to be casual and overlook this fact since you don't listen to your own signal. The following sub-sections provide information that will help you tailor your transmitted signal.

■ Changing Transmit Bandwidth (SSB/AM)

Use Menu No. 13 to change the transmit bandwidth between 2.4 kHz (normal) and 2.0 kHz (narrow). The default is 2.4 kHz.

Bandwidth	Lower Cut-off Frequency	Higher Cut-off Frequency
2.4 kHz (Normal)	300 Hz	2.7 kHz
2.0 kHz (Narrow)	500 Hz	2.5 kHz

■ Equalizing Transmit Audio (SSB/FM/AM)

Use Menu No. 14 to change the transmit frequency characteristics of your signal. You can select from five different transmit profiles including the default flat response. Selecting any of the following items from the Menu causes "TX EQ." to appear on the display.

- **High boost (Hb):**
Emphasizes higher audio frequencies; effective for a bassy voice.
- **Formant pass (FP):**
Improves clarity by suppressing audio frequencies outside the normal voice frequency range.
- **Bass boost (bb):**
Emphasizes lower audio frequencies; effective for a voice with more high frequency components.
- **Conventional (c):**
Emphasizes by 3 dB frequencies at 600 Hz and higher.

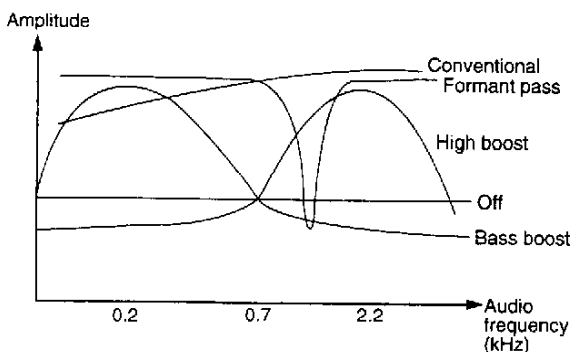

TRANSMIT INHIBIT

Transmit Inhibit prevents the transceiver from being placed in the transmit mode. No signals can be transmitted if this function is ON.

- **TX Inhibit OFF:** Transmissions are possible.
- **TX Inhibit ON:** Transmissions are not possible.

Switch the function ON or OFF via Menu No. 38. The default is OFF.

CHANGING FREQUENCY WHILE TRANSMITTING

Moving your frequency while transmitting is usually an unwise practice due to the risk of interference to other stations. However, if necessary, by using the **Tuning** control you can change the operating frequency while transmitting. You also can change the XIT offset frequency in the transmit mode.

While transmitting, if you select a frequency outside the transmit frequency range, the transceiver is automatically forced to receive mode. If you selected transmit mode by pressing **[SEND]**, transmission will not resume until you select a frequency inside the transmit frequency range, and you press **[SEND]** again.

8 COMMUNICATING AIDS

CW BREAK-IN

Break-in allows you to transmit CW without manually switching between transmit and receive modes. Two types of Break-in are available, Semi Break-in and Full Break-in.

Semi Break-in:

When the key contacts open, the transceiver automatically waits for the passage of the time period that you have selected. The transceiver then returns to the receive mode.

Full Break-in:

As soon as the key contacts open, the transceiver returns to the receive mode.

USING SEMI BREAK-IN OR FULL BREAK-IN

- 1 Press [CW/FSK] to select CW mode.
 - "CW" appears.
- 2 Press [VOX].
 - "VOX" appears.
- 3 Press [DELAY].
 - The current setting (Full or delay time) appears. The default is Full ("FBk").

8

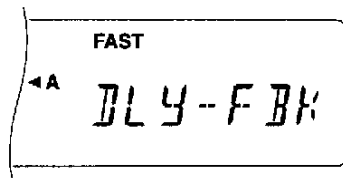

- 4 Turn the **MULT/CH** control to select Full Break-in or a delay time for Semi Break-in.
 - Available delay times are from 5 to 100 (50 ms to 1000 ms) in steps of 5.
- 5 Begin sending.
 - The transceiver automatically switches to the transmit mode.
 - **When Full is selected:** The transceiver immediately switches to the receive mode when the key opens.
 - **When a delay time is selected:** The transceiver switches to the receive mode after the delay time that you have selected has passed.
- 6 Press [DELAY] again.

Note: Full Break-in cannot be used with the TL-922/922A amplifier.

ELECTRONIC KEYS

This transceiver has a built-in electronic keyer that can be used by connecting a keyer paddle to the transceiver's rear panel. Consult "Keys and Keyboards for CW Operation" (page 3) for details regarding this connection. This built-in keyer supports lambic operation.

CHANGING KEYING SPEED

The keying speed of the electronic keyer is fully adjustable. Selecting the appropriate speed is important in order to send error-free CW that other operators can copy solidly. Selecting a speed that is beyond your keying ability will only result in mistakes. If you select a speed that is close to the speed used by the other station, you will obtain the best results.

- 1 Press [CW/FSK] to select CW mode.
 - "CW" appears.
- 2 Press [KEY].
 - The current keying speed appears. The default is 20.

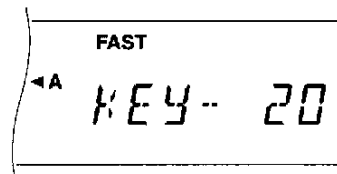

- 3 While keying the paddle and listening to the transmit sidetone, turn the **MULT/CH** control to select the appropriate speed.
 - The selectable range is 0 to 100 in steps of 2. The larger the number, the faster the speed.
- 4 Press [KEY] again to complete the setting.

Note: When using the semi-automatic "Bug" function, the selected speed applies only to the rate that dots are sent.

AUTO WEIGHTING

The electronic keyer can automatically change the dot/dash weighting. Weighting is the ratio of dash length to dot length. The weighting changes with your keying speed thus making your keying easier for other operators to copy.

Use Menu No. 26 to switch Auto Weighting ON or OFF. The default is ON. When Auto Weighting is OFF, the weighting is locked at 3:1.

■ Reversible Auto Weighting

Auto Weighting increases the weighting as you increase your keying speed. However, the electronic keyer also can decrease the weighting as you reduce your keying speed.

To switch this function ON, access Menu No. 27, and select ON. The default is OFF.

BUG KEY FUNCTION

The built-in electronic keyer also can be used as a semi-automatic key. Semi-automatic keys are also known as "Bugs". When this function is ON, dots are generated in the normal manner by the electronic keyer. Dashes, however, are manually generated by the operator by holding the keyer paddle closed for the appropriate length of time for each dash.

To switch this function ON, access Menu No. 22, and select ON. The default is OFF.

Note: When the Bug Key function is ON, CW Message Memory (see below) cannot be used.

CW MESSAGE MEMORY

This transceiver has three memory channels for storing CW messages. Each memory channel can store approximately 50 characters. These memory channels are ideal for storing contest exchanges that you want to send repeatedly. Stored messages can be played back to check message content or for transmitting.

The electronic keyer has a function that allows you to interrupt playback and manually inject your own keying. To switch this function ON, access Menu No. 28, and select ON. The default is OFF.

The electronic keyer also can repeatedly play back the message that you stored. To switch this function ON, access Menu No. 23 and select ON. The default is OFF.

For repetitive message playback, you can change the interval between each series of messages. Use Menu No. 24, and select the time in the range of 0 to 60 seconds.

Note:

- ◆ This function cannot be used when the Bug Key function is ON.
- ◆ Operating the keyer paddle with Menu No. 28 OFF cancels message playback. Even if message playback does not stop because of your keying start timing, you can cancel playback by pressing [CLR].

Storing CW Messages

- 1 Press [CW/FSK] to select CW mode.
 - "CW" appears.
- 2 If "VOX" is visible, press [VOX].
 - "VOX" disappears.
- 3 Press [REC].

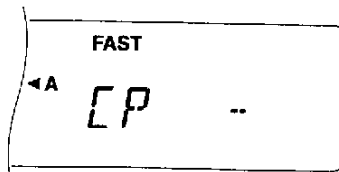

- 4 Press [CH 1], [CH 2], or [CH 3] to select a memory channel.

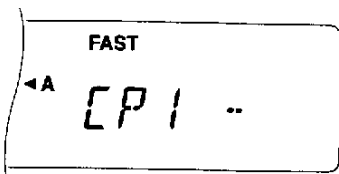

- 5 Begin sending using the keyer paddle.
 - The message you send is stored in memory.
- 6 To complete the message storage, press [REC] or [CLR].
 - When the memory becomes full, recording automatically stops.

Note: While not operating the keyer paddle after pressing a memory channel button, a pause is stored in the channel.

Checking CW Messages without Transmitting

- 1 Press [CW/FSK] to select CW mode.
 - "CW" appears.
- 2 If "VOX" is visible, press [VOX].
 - "VOX" disappears.
- 3 Press [CH 1], [CH 2], or [CH 3] to select the channel that has the desired message stored.
 - The message plays.
 - To play back the messages stored in the other channels in sequence, press the corresponding channel buttons during playback. Up to three channels can be queued at the same time.
 - To interrupt playback, press [CLR].

Transmitting CW Messages

Messages can be transmitted using Semi Break-in/ Full Break-in or manual TX/RX switching.

- 1 Press [CW/FSK] to select CW mode.
 - "CW" appears.
- 2 To use Semi Break-in/Full Break-in, press [VOX]; otherwise, press [SEND].
- 3 Press [CH 1], [CH 2], or [CH 3] to select the channel that stores the desired message.
 - The message is transmitted.
 - To transmit the messages stored in the other channels in sequence, press the corresponding channel buttons during playback. Up to three channels can be queued at the same time.
 - To interrupt transmission, press [CLR].
- 4 If [SEND] was pressed in step 2, press [SEND] again to return to receive mode.

REJECTING INTERFERENCE

IF FILTER

The IF filters are designed for selecting the exact range of intermediate frequencies that are sent to the next stage in the receive circuit. Interference adjacent to the desired signal can be reduced by selecting a narrow bandwidth filter and/or shifting the center frequency of the filter.

To more effectively remove interference, use the IF filters with the DSP filters described on pages 37 and 38.

CHANGING IF FILTER BANDWIDTH

When adjacent frequency interference is present at both sides of the desired signal, a narrow IF filter bandwidth may be the best way to remove the interference. Changing the filter bandwidth will not effect the current receive frequency.

To use a narrow filter in SSB, CW, or FSK mode, install the appropriate optional filter (page 58), and select the appropriate setting in Menu No. 46.

When in CW or FSK mode, the wide filter or the narrow filter is automatically selected, depending on the bandwidth of the DSP filter that you select. Refer to "CHANGING RECEIVE BANDWIDTH" (page 37). The default in SSB or AM mode is wide bandwidth. In FM mode, you cannot change the filter bandwidth.

Note: When you use Menu B, make sure to select the appropriate filter bandwidth via Menu No. 46 in Menu B.

9

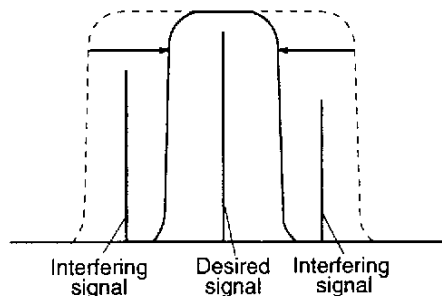

- 1 Select SSB or AM mode.
- 2 Press [FILTER].
 - The current filter selection appears.

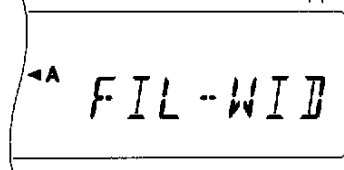

- 3 Turn the **MULTI/CH** control to select Wide ("FIL-WID") or Narrow ("FIL-NAR").
- 4 Press [FILTER] to complete the setting.

IF SHIFT

For SSB, CW, or FSK mode, shifting the center frequency of the filter pass band is an additional method of fighting adjacent frequency interference. Shifting this center frequency does not change the current receive frequency.

To remove interference that is higher in frequency than the desired signal, turn the **IF SHIFT** control counterclockwise. To remove interference that is lower in frequency than the desired signal, turn the **IF SHIFT** control clockwise.

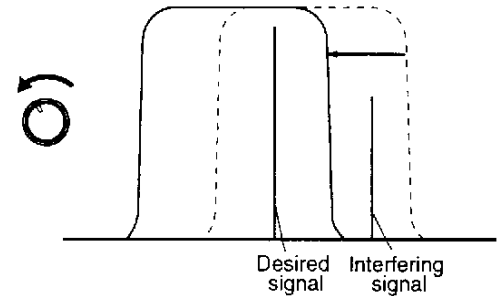

NOISE BLANKER

Noise Blanker was designed to reduce pulse noise such as that generated by automobile ignitions. Noise Blanker does not function in FM mode.

Press [NB] to toggle Noise Blanker ON or OFF.

- "NB" appears when the function is ON.

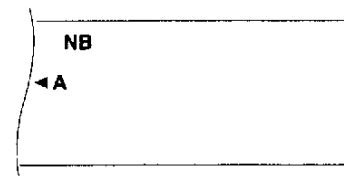

ATTENUATOR

Attenuator reduces the level of received signals. This function is useful when interference from adjacent frequencies is strong.

Press **[ATT]** to toggle Attenuator ON or OFF.

- “ATT” appears when the function is ON.

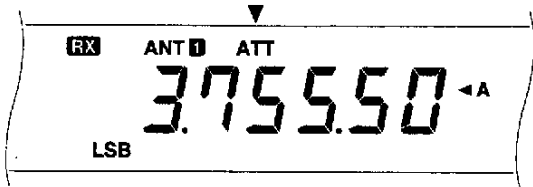

The ON/OFF setting will automatically be stored in the current band. Each time you select the same band, the same setting will automatically be selected.

The frequency range of each band is shown below.

Frequency range (MHz)	Frequency range (MHz)
0.03 ~ 2.50	14.50 ~ 18.50
2.50 ~ 4.10	18.50 ~ 21.50
4.10 ~ 7.50	21.50 ~ 25.50
7.50 ~ 10.50	25.50 ~ 30.00
10.50 ~ 14.50	30.00 ~ 60.00 (TS-570S)

PREAMPLIFIER

Switching Preamp OFF also may help to reduce interference from adjacent frequencies.

Press **[PRE-AMP]** to toggle ON or OFF.

- “PRE-AMP” appears when the function is ON.

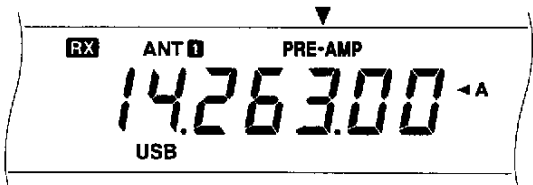

The ON/OFF setting will automatically be stored in the current band. Each time you select the same band, the same setting will automatically be selected.

The frequency range of each band is the same as for the Attenuator. The default of Preamp is OFF for the bands from 30 kHz to 7.5 MHz, and ON for the bands from 7.5 MHz to 60.0 MHz (TS-570D: 30.0 MHz).

Note: Switching Preamp OFF has the same effect as activating the AIP function on other KENWOOD transceivers.

DSP TOOLS

KENWOOD digital signal processing (DSP) technology is used for the functions described in this section.

CHANGING RECEIVE BANDWIDTH

For improving the interference reduction capability, this transceiver also provides audio frequency (AF) filters designed using DSP technology. When in SSB, FM, or AM mode, you can change the filter bandwidth by altering its low cut-off frequency and/or high cut-off frequency. For CW and FSK modes, you can change the filter bandwidth by directly specifying a bandwidth. Changing the filter bandwidth does not affect the current receive frequency.

■ SSB/ FM/ AM Modes

- 1 Select SSB, FM, or AM mode.
- 2 Turn the **DSP SLOPE (LOW)** control clockwise to raise the low cut-off frequency, or counterclockwise to lower the low cut-off frequency.

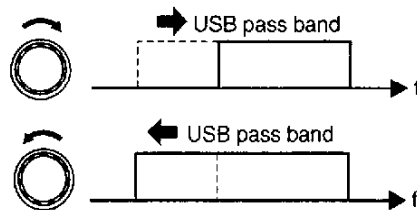

Turn the **DSP SLOPE (HIGH)** control clockwise to raise the high cut-off frequency, or counterclockwise to lower the high cut-off frequency.

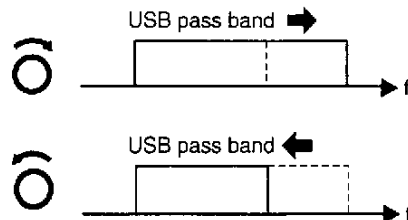

Adjust	Frequency Selections
DSP SLOPE (LOW) control	10, 50, 100, 150, 200, 250, 300, 350, 400, 450, 500, 550, 600, 650, 700, 750, 800, 850, 900, 950, 1000 Hz
DSP SLOPE (HIGH) control	1.0, 1.1, 1.2, 1.3, 1.4, 1.5, 1.6, 1.7, 1.8, 2.0, 2.2, 2.4, 2.6, 2.8, 3.0, 3.2, 3.4, 3.6, 4.0, 4.4, 5.0 kHz

The default cut-off frequencies depend on the current positions of the **DSP SLOPE** controls.

9 REJECTING INTERFERENCE

■ CW/ FSK Modes

- 1 Select CW or FSK mode.
- 2 Press **[FILTER]**.
 - The current filter selection appears.
- 3 Turn the **MULTI/CH** control clockwise to widen the bandwidth, or counterclockwise to narrow the bandwidth.

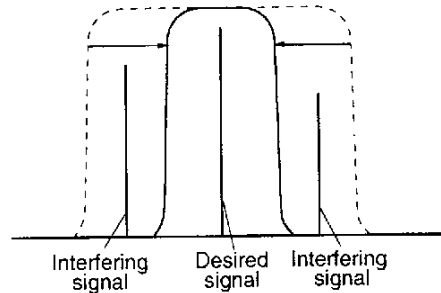

- 4 Press **[FILTER]** to complete the setting.

Mode	Bandwidth Selections (Hz)	Default (Hz)
CW	50, 100, 200, 300, 400, 600, 1.0 k, 2.0 k	600
FSK	250, 500, 1.0 k, 1.5 k	1.5 k

Depending on which bandwidth you select for the DSP filter and which type of optional filter you install, the wide IF filter or the narrow IF filter will automatically be selected.

9

Optional Filter	Mode	DSP Filter Bandwidth	IF Filter Bandwidth
YK-88SN-1 SSB (1.8 kHz)	CW	2.0 kHz	Wide
		1.0 kHz or lower	Narrow
	FSK	1.5 kHz	Wide
		250 Hz, 500 Hz, 1.0 kHz	Narrow
YK-88C-1 CW (500 Hz)	CW	1.0 kHz, 2.0 kHz	Wide
		600 Hz or lower	Narrow
	FSK	1.0 kHz, 1.5 kHz	Wide
		250 Hz, 500 Hz	Narrow
YK-88CN-1 CW (270 Hz)	CW	300 Hz or higher	Wide
		50 Hz, 100 Hz, 200 Hz	Narrow

BEAT CANCEL

Beat Cancel uses an adaptive filter and attenuates more than one cyclic interference within the receive pass band. The adaptive filter changes its characteristics according to the nature of the signal being received at a given moment. You can use Beat Cancel when in SSB, FM, or AM mode.

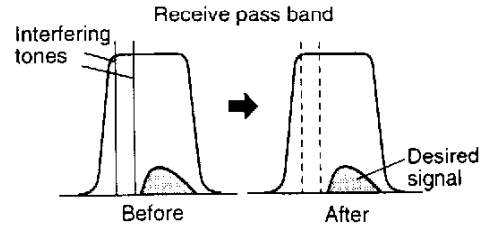

Press **[B.C.]** to toggle Beat Cancel ON or OFF.

- "BEAT CANCEL" appears when the function is ON.

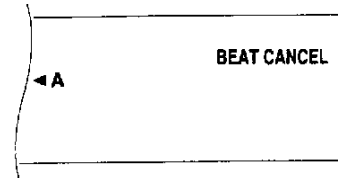

Note: While receiving intermittent CW signals, the transceiver sounds clicks. This does not indicate a malfunction.

NOISE REDUCTION

This transceiver provides two types of Noise Reduction functions, 1 and 2, for reducing random noise which interferes with the desired signal. Just trying them both is the easiest way to judge which function works more effectively under the current condition. Normally select Noise Reduction 1 in SSB mode and select Noise Reduction 2 in CW mode.

Note: Using Noise Reduction 2 in SSB mode may lower the clarity of signals or induce pulse noise depending on conditions.

Press **[N.R.]** to toggle between Noise Reduction 1, Noise Reduction 2, and OFF.

- "N. R. 1" or "N.R. 2" appears depending on which function is selected.

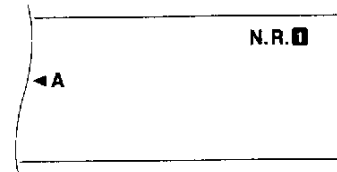

■ Setting NR2 Time Constant

You can change the correlation time for Noise Reduction 2. When in SSB, select the correlation time that allows you to hear signals with more clarity. When receiving CW, it is best to select the longest correlation time that allows reliable reception. The longer the correlation time, the better S/N.

Access Menu No. 12 and select 7.5 ms or 20 ms. The default is 20 ms.

MEMORY FEATURES

MICROPROCESSOR MEMORY BACKUP

This transceiver uses a lithium battery to retain the user-specified memory items. Switching OFF the power will not erase the Menu setups or memory channels. The lithium battery life is approximately 5 years.

If you find the transceiver powers-up with default settings, and VFO and memory channel data is lost, have the lithium battery replaced. Contact an authorized **KENWOOD** service facility or dealer.

CONVENTIONAL MEMORY

Conventional memory is used for storing data that you want to recall many times in the future. For example, you may store the frequency where you regularly meet your club members.

This transceiver provides 100 Conventional memory channels, in total, numbered 00 to 99. Channels 90 to 99 are designed for programming VFO tuning ranges and scan ranges. The data that you can store is listed below:

Parameter	Channel 00 - 89	Channel 90 - 99
RX frequency	Yes	Yes ¹ (simplex)
TX frequency	Yes	
Mode for RX	Yes	Yes ¹ (simplex)
Mode for TX	Yes	
Start/end frequencies	No	Yes
Subtone frequency	Yes	Yes
Tone ON/OFF	Yes	Yes
CTCSS ON/OFF	Yes	Yes
Memory Channel Lockout ON/OFF	Yes ¹	Yes ¹

¹ Changing the data after recalling a memory channel overwrites the contents of the channel.

STORING DATA IN MEMORY

There are 2 methods for storing transmit/receive frequencies and associated data in memory channels 00 to 89. Use either method depending on the relationship of the receive and transmit frequencies that you store:

- Simplex channels:
RX frequency = TX frequency
- Split-frequency channels:
RX frequency ≠ TX frequency

Memory channels 90 to 99 can also be used as simplex channels.

Note: When RIT or XIT is ON, the frequency that includes the RIT or XIT offset will be stored.

■ Simplex Channels

- 1 Press **[A/B]** to select VFO A or VFO B.
 - "◀ A" or "◀ B" appears to show which VFO is selected.
- 2 Select the frequency, mode, etc. to be stored.
- 3 Press **[M.IN]** to enter Memory Scroll mode.

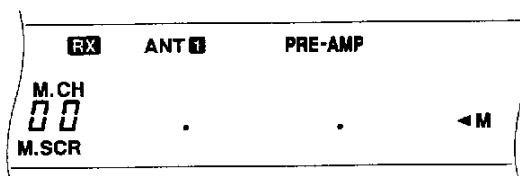

- To exit Memory Scroll mode and abort the storage process, press **[CLR]**.
- 4 Turn the **MULTI/CH** control, or press Mic **[UP]** or **[DOWN]** to select a memory channel.
 - Entering a 2-digit number such as 05 using the numeric keys can also be used to select a channel.

10

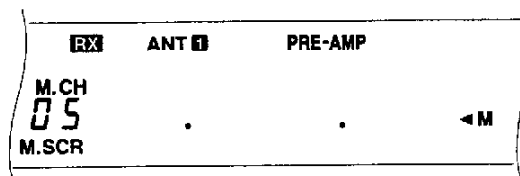

- 5 Press **[M.IN]** again to store the data.
 - The previous data stored in the channel is overwritten.

10 MEMORY FEATURES

■ Split-Frequency Channels

- 1 Press **[A/B]** to select VFO A or VFO B.
 - “◀A” or “◀B” appears to show which VFO is selected.
- 2 Select the frequency, mode, etc. to be stored.
 - The frequency and mode selected here will be used for transmitting.
- 3 Press **[A/B]** to select the other VFO.
- 4 Select the receive frequency and mode.
- 5 Press **[SPLIT]**.
 - “SPLIT” appears.

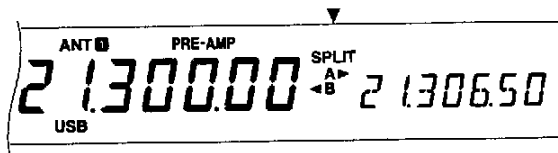

- 6 Press **[M.IN]** to enter Memory Scroll mode.

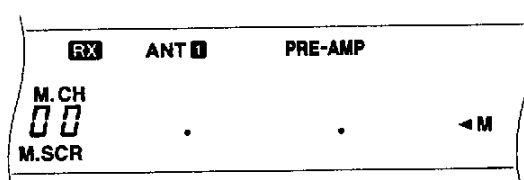

- To exit Memory Scroll mode and abort the storage process, press **[CLR]**.

- 7 Turn the **MULTI/CH** control, or press Mic **[UP]** or **[DWN]** to select a memory channel.
 - Entering a 2-digit number such as 05 using the numeric keys can also be used to select a channel.

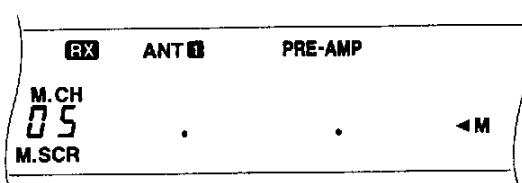

- 8 Press **[M.IN]** again to store the data.
 - The previous data stored in the channel is overwritten.

Note: When subtone frequencies differ between TX and RX while performing memory-VFO split operation, the subtone frequency for RX will be stored in the memory channel.

MEMORY RECALL AND SCROLL

There are two modes that allow you to retrieve frequencies and associated data that you stored in a memory channel: Memory Recall and Memory Scroll.

Memory Recall:

In this mode, the transceiver receives and transmits using a frequency that you retrieve. You can temporarily change the frequency and associated data without overwriting the contents of the memory channel.

Memory Scroll:

Use this mode to check the contents of memory channels without changing the current receive frequency. In this mode, frequencies that you retrieve are not used for receiving and transmitting.

■ Memory Recall

- 1 Press **[M/V]** to enter Memory Recall mode.
 - The memory channel that was last selected appears.

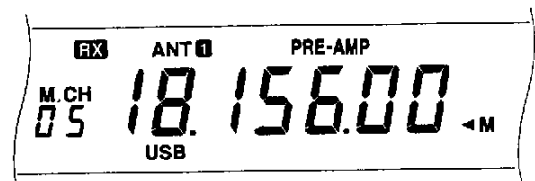

- 2 Turn the **MULTI/CH** control, or press Mic **[UP]** or **[DWN]** to select a memory channel.
 - Continuously holding down Mic **[UP]** or **[DWN]** steps the transceiver through the memory channels until the button is released.
 - The memory channels that contain no data are skipped.
 - You cannot change memory channels while transmitting.
- 3 To exit Memory Recall mode, press **[M/V]**.

Note: Memory channels can also be changed while using the TF-SET function.

■ Memory Scroll

- 1 Press **[M.IN]** to enter Memory Scroll mode.
 - The memory channel that was last selected appears.

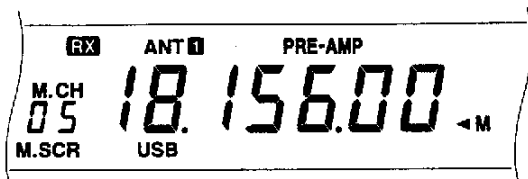

- 2 Turn the **MULT/CH** control, or press Mic **[UP]** or **[DWN]** to step through the memory channels.
 - Entering a 2-digit number such as 05 using the numeric keys can also be used to change channels.
- 3 To exit Memory Scroll mode, press **[CLR]**.
 - The transceiver re-displays the memory channel or VFO frequency that was selected before you activated Memory Scroll.

■ Temporary Frequency Changes

After retrieving frequencies and associated data in Memory Recall mode, you can temporarily change the data without overwriting the contents of the memory channel.

- 1 Access Menu No. 08 and select ON.
 - Skip this step when changing only the associated data.
- 2 Recall a memory channel.
- 3 Change the frequencies and associated data.
 - Use only the **Tuning** control to select a frequency.
- 4 If necessary for future use, store the changed data in another memory channel. Refer to "Channel → Channel Transfer" (page 42).

Note: Memory channel data can also be changed while using the TF-SET function.

■ Memory-VFO Split Operation

Under "SPECIALIZED COMMUNICATING" (page 23), you learned split-frequency operation using two VFOs. Recalling a split-frequency channel is another way to do split-frequency operation. If you access Menu No. 07 and select ON, you can also use a memory channel and a VFO together for this operation, as follows:

- RX: Memory channel
TX: VFO A or VFO B
- RX: VFO A or VFO B
TX: Memory channel

To use a memory channel for receiving:

- 1 Press **[A/B]** to select the VFO that you will use for transmitting.
 - "◀A" or "◀B" appears to show which VFO is selected.
- 2 Select the frequency for transmitting.
- 3 Recall a memory channel
- 4 Press **[SPLIT]** to start split-frequency operation.

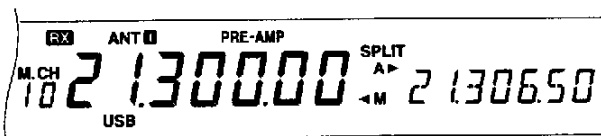

- If you selected VFO B in step 1, press **[SPLIT]** once again.
- 5 Press **[M/V]** to quit split-frequency operation.
- To use a memory channel for transmitting:**
- 1 Recall a memory channel.
 - 2 Press **[M/V]**.
 - 3 Press **[A/B]** to select the VFO that you will use for receiving.
 - 4 Select the frequency for receiving.
 - 5 Press **[SPLIT]** to start split-frequency operation.
 - 6 Press **[SPLIT]** again to use the memory channel that you recalled in step 1.

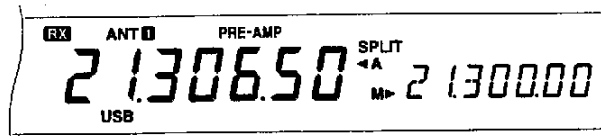

- 7 Press **[SPLIT]** once again to quit split-frequency operation.

10

10 MEMORY FEATURES

MEMORY TRANSFER

■ Memory → VFO Transfer

After retrieving frequencies and associated data in Memory Recall mode, you can copy this data to the VFO. This function is useful, for example, when the frequency you want to monitor is near the frequency stored in a memory channel.

- 1 Recall the desired memory channel.
- 2 Press **[M>VFO]**.
 - When a simplex channel is recalled, the data is copied to VFO A or VFO B, depending on which VFO was used to recall the channel.
 - When a split channel is recalled, the RX data is copied to VFO A and the TX data is copied to VFO B.

Note:

- ◆ The Memory Channel Lockout status and the subtone frequency are not copied.
- ◆ Pressing **[M>VFO]** after temporarily changing the retrieved data copies the new data to the VFO.

■ Channel → Channel Transfer

You can also copy the contents of one memory channel to another memory channel. This function is useful when storing frequencies and associated data that you temporarily change in Memory Recall mode.

- 1 Recall the desired memory channel.
- 2 Press **[M.IN]** to enter Memory Scroll mode.



- To exit Memory Scroll mode, press **[CLR]**.
- 3 Select the memory channel to which you would like this data copied.
 - 4 Press **[M.IN]** again.

The tables below illustrate how data is transferred between memory channels:

Channel 00 ~ 89	→	Channel 00 ~ 89
RX frequency	→	RX frequency
TX frequency	→	TX frequency
Mode for RX	→	Mode for RX
Mode for TX	→	Mode for TX
Subtone frequency	→	Subtone frequency
Tone ON/OFF	→	Tone ON/OFF
CTCSS ON/OFF	→	CTCSS ON/OFF
Memory Channel Lockout ON/OFF	→	Memory Channel Lockout OFF

Channel 00 ~ 89	→	Channel 90 ~ 99
RX frequency	→	TX/RX frequency Start frequency
TX frequency	→	End frequency
Mode for RX	→	Mode for TX/RX
Mode for TX	→	—
Subtone frequency	→	Subtone frequency
Tone ON/OFF	→	Tone ON/OFF
CTCSS ON/OFF	→	CTCSS ON/OFF
Memory Channel Lockout ON/OFF	→	Memory Channel Lockout OFF

Channel 90 ~ 99	→	Channel 00 ~ 89
TX/RX frequency	→	RX frequency TX frequency
Mode for TX/RX	→	Mode for RX Mode for TX
Subtone frequency	→	Subtone frequency
Tone ON/OFF	→	Tone ON/OFF
CTCSS ON/OFF	→	CTCSS ON/OFF
Memory Channel Lockout ON/OFF	→	Memory Channel Lockout OFF

Channel 90 ~ 99	→	Channel 90 ~ 99
TX/RX frequency	→	TX/RX frequency
Mode for TX/RX	→	Mode for TX/RX
Start frequency	→	Start frequency
End frequency	→	End frequency
Subtone frequency	→	Subtone frequency
Tone ON/OFF	→	Tone ON/OFF
CTCSS ON/OFF	→	CTCSS ON/OFF
Memory Channel Lockout ON/OFF	→	Memory Channel Lockout OFF

STORING FREQUENCY RANGES

Memory channels 90 to 99 allow you to store frequency ranges for VFO tuning and Program Scan. Program Scan is described in the next chapter. To tune or scan frequencies in a desired range only, store start and end frequencies for that range in advance.

- 1 Press **[A/B]** to select VFO A or VFO B.
 - “◀A” or “◀B” appears to show which VFO is selected.
- 2 Select the end frequency and mode.
- 3 Press **[A/B]** to select the other VFO.
- 4 Select the start frequency.
- 5 Press **[SPLIT]**.
 - “SPLIT” appears.

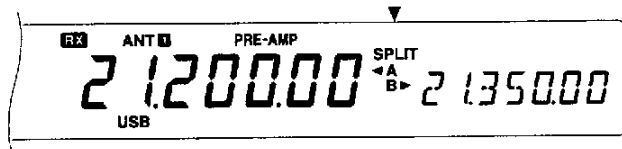

- 6 Press **[M.IN]** to select Memory Scroll mode.

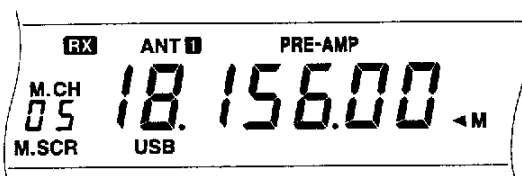

- To exit Memory Scroll mode and abort the storage process, press **[CLR]**.
- 7 Turn the **MULTI/CH** control, or press Mic **[UP]** or **[DWN]** to select a memory channel in the range from 90 to 99.
 - Entering a 2-digit number such as 90 using the numeric keys can also be used to select a channel.

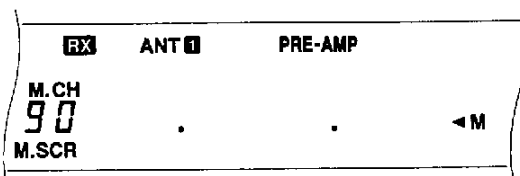

- 8 Press **[M.IN]** again to store the data.
 - The previous data stored in the channel is overwritten.

■ **Confirming Start/End Frequencies**

Use this procedure to check the start and end frequencies that you stored in channels 90 to 99.

- 1 Press **[M/V]** to enter Memory Recall mode.
- 2 Turn the **MULTI/CH** control, or press Mic **[UP]** or **[DWN]** to select a memory channel.
- 3 Press **[DOWN]** to check the start frequency and press **[UP]** to check the end frequency.

■ **Programmable VFO**

Using the start and end frequencies that you stored in channels 90 to 99, Programmable VFO restricts the frequency range that you can tune with the **Tuning** control. One application of this function is to help you operate within the authorized frequency limits of your license.

- 1 Press **[M/V]** to enter Memory Recall mode.
- 2 Turn the **MULTI/CH** control, or press Mic **[UP]** or **[DWN]** to select a memory channel.

Now you can only tune from the start frequency to the end frequency

ERASING MEMORY CHANNELS

If there are memory channels that you will not recall in the future, you may prefer erasing the contents of those channels.

- 1 Press **[M/V]** to enter Memory Recall mode.
- 2 Turn the **MULTI/CH** control, or press Mic **[UP]** or **[DWN]** to select a memory channel.
- 3 Press **[CLR]** for approximately two seconds.
 - A beep sounds to confirm that the channel data is erased.



■ **Full Reset**

Do Full Reset if you want to erase all data in all memory channels. Note that this function resets all settings, that you customized, to the factory defaults, i.e. menu settings, quick memory, etc.

To do Full Reset, press **[A=B]+ POWER ON**.

10 MEMORY FEATURES

■ Memory Channel Lockout

You can lock out Conventional memory channels that you prefer not to monitor during Memory Scan. Memory Scan is described in the next chapter.

- 1 Press **[M/V]** to enter Memory Recall mode.
- 2 Turn the **MULT/CH** control, or press Mic **[UP]** or **[DWN]** to select a memory channel.
- 3 Press **[CLR]**.
 - Release **[CLR]** immediately. Pressing it for more than approximately 2 seconds erases the contents of the memory channel.
 - A dot appears beside the right-most digit of the memory channel number to indicate the channel has been locked out.

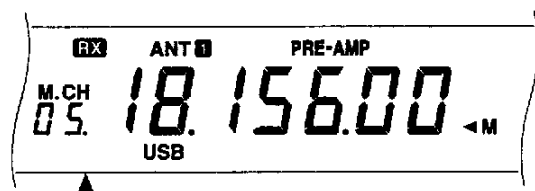

- Repeatedly pressing **[CLR]** adds and removes the channel from the scan list.

QUICK MEMORY

Quick memory is designed for quickly and temporarily saving data without specifying a particular memory channel. Use Quick memory to store data that you will not need during future operating sessions. For example, as you tune across the band looking for DX, it is convenient to store stations that you want to contact. You can quickly jump between several different memory channels as you monitor them.

This transceiver provides five Quick memory channels that can store the following data:

RX frequency	TX frequency
Mode for RX	Mode for TX
RIT/XIT offset	Microphone gain
Transmit power	Keying speed
VOX delay time	Break-in delay time
Receive filter bandwidth ¹	VOX ON/OFF
Speech Processor ON/OFF	Noise Blanker ON/OFF
Subtone ON/OFF	CTCSS ON/OFF
1 MHz Step ON/OFF	Fine Tuning ON/OFF
RIT ON/OFF	XIT ON/OFF

¹DSP SLOPE control settings are not stored.

STORING INTO QUICK MEMORY

Each time you store a new frequency, all previously stored frequencies are bumped to their next respective Quick memory channel. When all five memory channels contain frequencies, storing one more frequency bumps the contents of memory channel 5 off the stack (data lost).

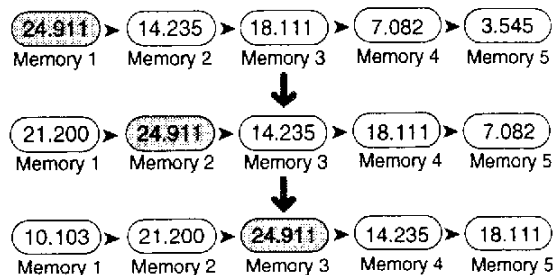

You can store data in Quick memory only when using VFO frequencies for both transmitting and receiving.

- 1 Select the frequency, mode, etc.
- 2 Press QUICK MEMO **[M.IN]**.
 - Each time **[M.IN]** is pressed, the current VFO data is written to Quick memory.

Note: When RIT or XIT is ON, this ON status and the offset also will be stored.

RECALLING QUICK MEMORY

You can recall a Quick memory channel, only when using VFO frequencies for both transmitting and receiving.

- 1 Press QUICK MEMO [MR].
 - The current memory channel number appears.

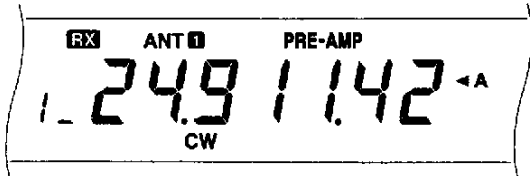

- If there is no data stored in any Quick memory channel, then this step will not access Quick memory.
- 2 Turn the **MULT/CH** control to select a Quick memory channel (1 to 5).
 - You cannot change memory channels while transmitting.
 - 3 To exit, press QUICK MEMO [MR] again.

Note: Memory channels cannot be changed while using the TF-SET function.

TEMPORARY FREQUENCY CHANGES

After recalling a Quick memory channel, you can temporarily change the data without overwriting the contents of the channel. You can change the frequency even when you select OFF in Menu No. 08.

- 1 Press QUICK MEMO [MR].
- 2 Turn the **MULT/CH** control to select a Quick memory channel (1 to 5).
- 3 Change the frequencies and associated data.
- 4 To store the changed data in Quick memory, press QUICK MEMO [M.IN].
 - This action stores the new data in the current channel and bumps the old frequency to the next higher Quick memory channel.
- 5 To exit, press QUICK MEMO [MR] again.

Note: Memory channel data can also be changed while using the TF-SET function.

QUICK MEMORY → VFO TRANSFER

This function copies the contents of the memory channel that you recalled, to the VFO.

- 1 Recall a Quick memory channel.
- 2 Press [M>VFO].

Note: Pressing [M>VFO] after temporarily changing the recalled data copies the new data to the VFO.

SCAN

Scan is a useful function for hands-off monitoring of your favorite frequencies. By becoming comfortable with how to use all types of Scan, the monitoring flexibility gained will increase your operating efficiency.

The transceiver provides the following types of Scan:

Scan Type		Purpose
Program Scan		Monitors frequencies in the range that you select.
Memory Scan	All-channel Scan	Monitors all RX frequencies that you store in the Conventional memory channels.
	Group Scan	Monitors all RX frequencies stored in the Conventional memory channels of the desired group.

PROGRAM SCAN

Program Scan monitors the range between the start frequency and the end frequency that you store in Conventional memory channels 90 to 99. For a refresher on how to store Program Scan limits, refer to "STORING FREQUENCY RANGES" (page 43).

You can select a maximum of 10 memory channels and sequentially scan the ranges that you previously stored in those channels. Program Scan starts with the smallest channel number and repeats the sequence as shown below.

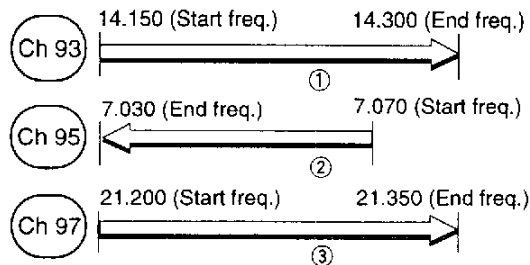

11

- 1 Press **[A/B]** to select VFO A or VFO B.
- 2 Press and hold down **[SCAN]**, then using the numeric keys enter the second digit of each memory channel you desire to scan, i.e. 3 for Ch 93, 357 for Ch 93/Ch 95/Ch 97, etc.
- 3 Release **[SCAN]** to start Program Scan.

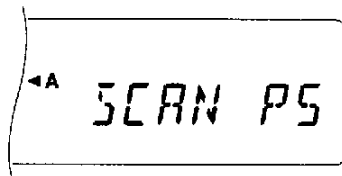

- Releasing **[SCAN]** before entering channel numbers selects the channels that you selected last time for Program Scan.
- To jump to the desired frequency while scanning, turn the **Tuning** control or **MULT/CH** control, or press Mic **[UP]/[DWN]**.
- When in a mode other than FM, turning the **RIT/XIT** control clockwise decreases the scan speed, and counterclockwise increases the speed. "P1" to "P9" on the display show the current speed (P1: maximum, P9: minimum).
- When in FM mode, Scan automatically stops on a channel in which a signal is present. The transceiver remains on the same channel for either a short time (Time-operated mode) or until the signal drops (Carrier-operated mode), depending on which one you select via Menu No. 10. Refer to "MEMORY SCAN" for further information.

- 4 To stop Scan, press **[SCAN]** or **[CLR]**.

Note:

- ◆ If you have turned the **SQL** control clockwise far beyond the squelch threshold when in FM mode, Scan may fail to stop at a channel in which a signal is present. If this happens, turn the **SQL** control slightly counterclockwise.
- ◆ If you press **[SCAN]** before storing any frequency range, then the lower and upper frequency limits of the transceiver are stored in memory channel 90, and Program Scan is activated using this channel.
- ◆ When the current receive frequency is within one of the ranges that you select by channel numbers, Scan starts with the current frequency. The operating mode stored in the channel with that range is used.
- ◆ When the current receive frequency is outside all the ranges that you select by channel numbers, Scan starts with the start frequency stored in the smallest channel number.
- ◆ Operating mode can be changed during scanning, but the memory channel is overwritten with the changed mode.
- ◆ When the current Scan range is smaller than a single step of the **MULT/CH** control, turning this control clockwise causes Scan to jump to the start frequency, and counterclockwise to the end frequency.
- ◆ Starting Program Scan switches OFF the **RIT** and **XIT** functions.
- ◆ When in FM mode, Program Scan monitors rounded off frequencies regardless of the Menu No. 05 selection.

SCAN HOLD

This function stops Program Scan for approximately five seconds and then resumes Scan when you jump to the desired frequency by turning the **Tuning** control or **MULT/CH** control, or pressing Mic **[UP]/[DWN]**.

To use this function, access Menu No. 09, and select ON. The default is OFF.

MEMORY SCAN

Memory Scan monitors all memory channels in which you stored frequencies (All-channel Scan) or only a desired group of memory channels (Group Scan).

Scan automatically stops at a channel in which a signal is present. The transceiver remains on the same channel for either a short time (Time-operated mode) or until the signal drops (Carrier-operated mode). Use Menu No. 10 to select either mode. The default is Time-operated.

Time-operated mode:

After stopping on a busy channel and waiting approximately three seconds, Scan checks the channel again. If the channel is still busy, Scan waits another three seconds then restarts. If the channel is not busy three seconds after stopping, Scan restarts immediately.

Carrier-operated mode:

Scan restarts approximately two seconds after the signal drops.

You can lock out the memory channels that you prefer not to monitor while scanning. To do this refer to "Memory Channel Lockout" {page 44}.

ALL-CHANNEL SCAN

Use the following procedure to monitor all memory channels that contain frequency data.

- 1 Select Time-operated or Carrier-operated via Menu No. 10.
- 2 Press [**M/V**] to enter Memory Recall mode.
- 3 Turn the **SQL** control to adjust the squelch to threshold.
- 4 Press [**SCAN**] to start All-channel Scan.



- Scan starts with the current channel and ascends up through the channel numbers (this direction cannot be changed).
 - To jump to the desired channel while scanning, turn the **MULT/CH** control, or press Mic [**UP**]/**[DWN]**.
- 5 To stop Scan, press [**SCAN**] or [**CLR**].

Note:

- ◆ If you have turned the **SQL** control clockwise far beyond the squelch threshold, Scan may fail to stop at a channel in which a signal is present. If this happens, turn the **SQL** control slightly counterclockwise.
- ◆ Starting Memory Scan switches OFF the **RIT** and **XIT** functions.

GROUP SCAN

For the purpose of Group Scan, the 100 Conventional memory channels are divided into 10 groups, with each group containing 10 channels. The channels are grouped as follows:

Group 0	Ch 00, Ch 01, Ch 02, Ch 09
Group 1	Ch 10, Ch 11, Ch 12, Ch 19
Group 2	Ch 20, Ch 21, Ch 22, Ch 29
•	•
•	•
•	•
Group 9	Ch 90, Ch 91, Ch 92, Ch 99

You can select a maximum of 10 groups and sequentially scan the channels that belong to those groups. Group Scan starts with the smallest group number and repeats the sequence, for example, group 3 → group 5 → group 7 → group 3.

- 1 Select Time-operated or Carrier-operated via Menu No. 10.
- 2 Press [**MR**] to enter Memory Recall mode.
- 3 Turn the **SQL** control to adjust the squelch to the threshold.
- 4 Press and hold down [**SCAN**] then, using the numeric keys, enter the group numbers you desire to scan, i.e. 3 for group 3, 35 for groups 3 and 5, etc.
- 5 Release [**SCAN**] to start Group Scan.



- Scan ascends up through the channel numbers (this direction cannot be changed).
- To jump to the desired channel while scanning, turn the **MULT/CH** control, or press Mic [**UP**]/**[DWN]**.

- 6 To stop Scan, press [**SCAN**] or [**CLR**].

After using Group Scan, enter all group numbers in step 4 or do Full Reset {page 48} to use All-channel Scan (factory default). Note that doing Full Reset returns all settings, that you customized, to the factory defaults.

Note:

- ◆ If you have turned the **SQL** control clockwise far beyond the squelch threshold, Scan may fail to stop at a channel in which a signal is present. If this happens, turn the **SQL** control slightly counterclockwise.
- ◆ When the current channel is within one of the groups that you select by group number, Scan starts with the current channel.
- ◆ When the current channel is outside all the groups that you select by group number, Scan starts with the group number that is larger than and closest to the group number of the current channel.
- ◆ Starting Memory Scan switches OFF the **RIT** and **XIT** functions.



OPERATOR CONVENIENCES

MICROPROCESSOR RESET

If your transceiver seems to be malfunctioning, resetting the microprocessor default settings may resolve the problem.

INITIAL SETTINGS

For each VFO, the factory defaults for operating frequency and mode are as follows:

- VFO A: 14.000.000 MHz/ USB
- VFO B: 14.000.000 MHz/ USB

The Conventional and Quick memory channels have no data stored.

PARTIAL RESET

Do Partial Reset if a button or control does not function according to the instructions in this manual. The following are not erased by Partial Reset.

- Memory channel data
- Menu settings
- Antenna tuner preset data
- ANT 1/ANT 2 data.

To do Partial Reset, press **[A/B]+ POWER ON**.

- "HELLO" appears on the display.

FULL RESET

Do Full Reset if you want to erase all data in all memory channels. In addition, this function resets all settings, that you customized, to the factory defaults, i.e. menu settings, antenna tuner preset data, etc.

To do Full Reset, press **[A=B]+ POWER ON**.

- "HELLO" appears on the display.

Note: The IF filter selection in Menu No. 46 will not be reset.

12

SWITCHING ANT 1/ ANT 2

After connecting antenna feed line to the ANT 1 connector and/or ANT 2 connector on the rear panel, select ANT 1 or ANT 2, depending on which antenna is used for transmitting and receiving.

Press **[ANT]** to select ANT 1 or ANT 2.

- "ANT 1" or "ANT 2" appears to show which antenna is selected.

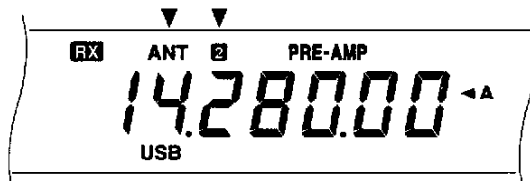

The ANT 1/ANT 2 setting will automatically be stored in the current band. Each time you select the same band, the same setting will automatically be selected.

The frequency range of each band is shown below.

Frequency Range (MHz)	Frequency Range (MHz)
0.03 ~ 2.50	14.50 ~ 18.50
2.50 ~ 4.10	18.50 ~ 21.50
4.10 ~ 7.50	21.50 ~ 25.50
7.50 ~ 10.50	25.50 ~ 30.00
10.50 ~ 14.50	30.00 ~ 60.00 (TS-570S)

Note: Connect an external antenna tuner to the ANT 1 connector only. After connecting this tuner correctly and selecting ANT 1, the internal tuner will always be bypassed.

FREQUENCY LOCK FUNCTION

Frequency Lock disables some buttons and controls to prevent you from accidentally activating a function or disturbing current settings.

Press **[F.LOCK]** to toggle Frequency Lock ON or OFF.

- "F.LOCK" appears when the function is ON.

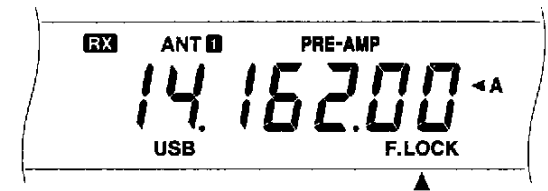

The following buttons and controls are disabled by Frequency Lock:

- Tuning control
- QUICK MEMO [MR]
- [FINE]
- [ENT]
- [FM/AM]
- [SPLIT]
- [A=B]
- [M.IN]
- MULTI/CH control
- QUICK MEMO [M.IN]
- [CLR]
- [LSB/USB]
- [1MHz]
- [A/B]
- [SCAN]
- [CW/FSK]
- [UP][DOWN]
- [MV]
- [M>VFO]

Note:

- ◆ After activating Frequency Lock, the **MULTI/CH** control and **[UP][DOWN]** are still available in Menu mode.
- ◆ After activating Frequency Lock, you can still change the transmit frequency with the Tuning control while using the TF-SET function.
- ◆ After activating Frequency Lock, the **MULTI/CH** control is still available for selections other than frequency and memory channel changes.
- ◆ After activating Frequency Lock, **[CLR]** is still available in some situations.

BEEP FUNCTION

The purpose of the Beep function is to provide an audible signal that conveys information. There are three types of signals:

- To confirm that a button has been pressed.
- To report an error condition; Morse codes are used for some errors.
- To confirm that the selection was completed by pressing **[MIC]**, **[PWR]**, **[KEY]**, **[DELAY]**, or **[FILTER]** again.

When selecting an operating mode, a Morse code abbreviation for that mode is heard.

Mode	Morse Code Output
LSB	· · · · (L)
USB	· · · (U)
CW	· · · · (C)
CW -R	· · · · · · (CR)
FSK	· · · (R)
FSK -R	· · · · · · (RR)
AM	· · (A)
FM	· · · (F)

You can change the volume of the beep output via Menu No. 01.

DISPLAY DIMMER

The Display illumination can be switched between 5 levels via Menu No. 00.

PROGRAM FUNCTION BUTTON

The transceiver allows you to customize the function of the front panel **[PF]** button. When using the optional MC-47 microphone, you can also customize the functions of the Mic **[PF1]**, **[PF2]**, **[PF3]**, and **[PF4]** buttons. You can assign the following types of functions to these buttons via Menu No. 41 to 45:

- Directly select Menu No. 00 to 40. No need to press **[MENU]** and turn the **MULTI/CH** control.
- Activate a function that is supported by no other front panel buttons.
- Activate the same function as one of the front panel buttons.

Consult the following table to select a function. Selecting OFF assigns no function to the button.

Function Number	Function	Function Number	Function
00 to 40	Selects Menu No 00 to 40. See "MENU CONFIGURATION"	65	[M/V]
		66	[A=B]
		67	[SCAN]
50	Monitor	68	[M>VFO]
51	Voice 1	69	[M.IN]
52	Voice 2	70	[CW TUNE]
		71	[CH 1]
60	QUICK MEMO [MR]	72	[CH 2]
		73	[CH 3]
61	QUICK MEMO [M.IN]	74	[FINE]
		75	[F. LOCK]
62	[SPLIT]	76	[CLR]
63	[TF-SET]	99	OFF
64	[A/B]		

- 1 Press **[MENU]**.
- 2 Press **[A/B]** to select Menu A or Menu B.
- 3 Turn the **MULTI/CH** control to select Menu No. 41, 42, 43, 44, or 45.

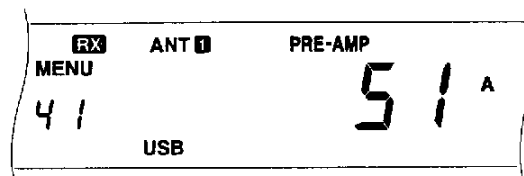

- 4 Press **[UP]**, **[DOWN]**, Mic **[UP]**, or Mic **[DWN]** to select a function number.
 - Consult the above table to select a function.
- 5 Press **[MENU]** to exit Menu mode.

The default values are as follows:

- Front panel **[PF]**: Voice 1
- Mic **[PF1]**: **[A/B]** • Mic **[PF2]**: **[SPLIT]**
- Mic **[PF3]**: **[M/V]** • Mic **[PF4]**: Monitor

Note: Full Reset returns the functions of the PF buttons to default settings.

12 OPERATOR CONVENIENCES

QUICK DATA TRANSFER

This transceiver has the capability to quickly and conveniently transfer the receive frequency and mode to another compatible transceiver. Compatible transceivers include:

- TS-570S/570D • TS-850S
- TS-870S • TS-690S
- TS-950SDX • TS-450S

Data Transfer could be useful while contesting. A spotting station that is searching for new contest multipliers can quickly transfer a frequency over to the running (main) station.

SETTING UP

■ Equipment Needed

In addition to a compatible transceiver, the following equipment is required:

Transfer to TS-570 or TS-870S:

- One cross-wired cable
This cable must have a 9-pin RS-232C female connector at both ends.

Transfer to a transceiver other than TS-570 and TS-870S:

- **KENWOOD** IF-232C interface unit
- One cross-wired cable
This cable must have a 9-pin RS-232C female connector at one end and a 25-pin RS-232C female connector at the other end.
- One straight cable
This cable must have a 6-pin DIN male connector at both ends.

■ Connections

For diagrams on how to connect the two transceivers, see "CONNECTING PERIPHERAL EQUIPMENT" (page 60).

12

USING QUICK TRANSFER

When connecting with another TS-570 or the TS-870S, use the same **COM** connector baud rate on each transceiver. If transferring to or from other **KENWOOD** transceivers, select 4800 bps and 2 stop bits on the TS-570. Use Menu No. 35 to select these parameters.

Note: While transferring data, other functions may work slowly.

■ Transferring Data

The TS-570 transceiver works as the Master sending data to the Slave transceiver.

- 1 Switch ON the Transfer function on each transceiver.
 - On the TS-570, access Menu No. 36 and select ON. For the compatible transceiver, check the instruction manual that came with the transceiver.
- 2 On the Master, while in VFO mode, select an operating frequency and mode.
- 3 On the Master, press QUICK MEMO [M.IN].
 - When using another TS-570 as the Slave, "CTRL" appears on the Slave.
 - The displayed data is stored in Quick memory channel 1 on the Master and transferred to the Slave.

Note: If the Master has RIT switched ON, the offset frequency is added to the receive frequency to be transferred.

■ Receiving Data

The TS-570 transceiver works as the Slave, receiving data from the Master transceiver. The Slave can receive data using either Quick memory channel 1 or the VFO.

- 1 Switch ON the Transfer function on each transceiver.
 - On the TS-570, access Menu No. 36 and select ON. For the compatible transceiver, check the instruction manual that came with the transceiver.
- 2 On the Slave, access Menu No. 37 and select either OFF (Quick memory channel 1) or ON (the VFO).
 - The default is Quick memory.
- 3 On the Master, perform the appropriate operation to send data.
 - For the correct method, check the instruction manual that came with the transceiver.

Note:

- ◆ If you always use the TS-570 just to receive, activate TX Inhibit via Menu No. 38 to avoid unintentional transmission.
- ◆ When the Slave receives data using the VFO programmed with a simplex frequency, the received data replaces the data on both VFOs. On the Slave, both RIT and XIT are set to OFF.
- ◆ When the Slave receives data using the VFOs programmed with split frequencies, the received data replaces the data only on the TX side of the VFO. On the Slave, XIT is set to OFF but RIT is not changed.

COMPUTER CONTROL

By connecting this transceiver to a computer, you can change the computer into an electronic console from which you can remotely control functions of the transceiver. This capability makes possible remote operation of your transceiver from across the room, from another room, or, when coupled with other commercially available products and where lawful, from another city, state, or country via a telephone connection.

Note:

- ◆ You can use the front panel controls while using computer control. Settings done from the front panel are effective immediately.
- ◆ After the computer is disconnected or turned off, all values and settings on the front panel are restored.

SETTING UP

■ Equipment Needed

- Computer equipped with an RS-232C serial port.
- One straight cable

This cable must have a 9-pin RS-232C female connector at one end, and at the other end a 9-pin or a 25-pin RS-232C female connector that mates with the RS-232C port of your computer.

- Transceiver control application

To design your programs consult "APPENDIX" {page 70} for the necessary information.

■ Connections

Connecting the transceiver to the computer is easy. See the diagram given in "CONNECTING PERIPHERAL EQUIPMENT" {page 60}.

Note: Before connecting this transceiver to the computer, switch OFF the power to the transceiver and the computer.

COMMUNICATION PARAMETERS

In order to control the transceiver by computer, you must first choose the communication parameters.

- 1 On the computer, configure your transceiver control application for 8 data bits and no parity.
- 2 On the transceiver, select the appropriate transfer rate and number of stop bits via Menu No. 35.
 - The defaults are 9600 bps and 1 stop bit.

Note: To reliably use the 38400 or 57600 bps transfer rates, the RS-232C port of the computer must support these high-speed communications parameters.

Menu Setting	Transfer Rate (bps)	Stop Bits
12 - 1	1200	1
24 - 1	2400	1
48 - 1	4800	1
48 - 2	4800	2
96 - 1	9600	1
192 - 1	19200	1
384 - 1	38400	1
576 - 1	57600	1

USING A TRANSVERTER

If you have a transverter that converts HF frequencies to VHF/UHF frequencies, and vice versa, you can use this HF transceiver as a VHF or UHF transceiver. For more information, consult the instruction manual that came with the transverter.

- 1 Connect the transverter to the ANT 1 or ANT 2 connector of this transceiver.
- 2 Select the operating frequency.
 - The transverter will use this frequency as the reference for converting frequencies.
 - Normally set 1 kHz and lower digits to 0 ("0.00" on the display).
- 3 Access Menu No. 40, and select 50 MHz, 144 MHz or 430 MHz, depending on which band you will use. The default is OFF.
 - Changing from the default (OFF) will automatically set the transmit power to approximately 5 W.
 - The transceiver displays a frequency down to the 10 Hz digit for 50 MHz, or down to the 100 Hz digit for 144 MHz and 430 MHz.

Note:

- ◆ When using a transverter, not all the functions of this transceiver are available.
- ◆ When using the optional VS-3 unit, the selected VHF or UHF frequencies are not announced.

12 OPERATOR CONVENIENCES

AUTOMATIC ANTENNA TUNER

As explained in "ANTENNA CONNECTION" (page 1), matching the impedance of the coaxial cable and antenna is very important. To do this, you have the choice of using the internal or an external tuner. This section describes how to use the internal tuner. For the external tuner, consult the instruction manual that comes with the tuner.

- 1 Select the transmit frequency.
- 2 Press **[ANT]** to select ANT 1 or ANT 2.
 - With an external tuner connected to the ANT 1 connector, you cannot select ANT 1 here. Selecting ANT 1 in this situation always causes the internal tuner to be bypassed.
- 3 Press **[AT TUNE]** and release it immediately.
 - "AT" appears to show that the internal tuner is in-line (not bypassed).

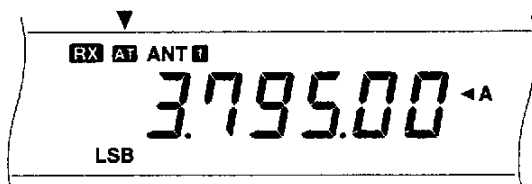

- 4 Press **[AT TUNE]** for more than one second.
 - CW mode is automatically selected and tuning starts.
 - "AT" blinks, and "TX" and "CW" appear.

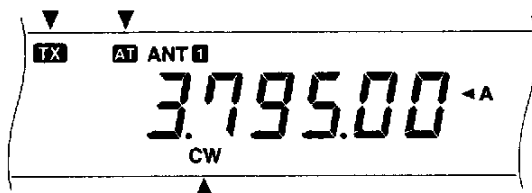

- To cancel tuning for any reason, press **[AT TUNE]** again.
- 5 See the display and check that tuning has successfully finished.
 - After successful tuning, "AT" stops blinking, and "TX" and "CW" disappear.
 - If tuning does not finish within about 20 seconds, an alarm sounds. Press **[AT TUNE]** to stop the alarm and tuning.

If you access Menu No. 11 and select ON, received signals will also pass through the internal tuner. This may reduce interference to the receive frequency.

Note:

- The internal tuner will not tune outside the authorized transmit limits of Amateur bands.
- Pressing **[AT TUNE]** for more than one second while transmitting interrupts transmitting and starts tuning.
- While using a different antenna tuner band for transmitting and receiving with Menu No. 11 ON, received signals bypass the internal tuner.
- While using CW Full Break-in, the internal tuner will be in-line for both transmitting and receiving.
- Tuning will automatically turn off after approximately 60 seconds. In addition, "AT" will disappear and the error beeps will stop.
- Tuning still may continue when the SWR meter indicates 1:1. This happens because of the tuning algorithm, and does not indicate a malfunction.
- Even though the SWR meter shows more than one segment, the internal tuner may not function for retuning. This does not indicate a malfunction. It happens because of an unavoidable SWR calculation algorithm error between 10 W (approx.) transmit power for tuning and 100 W transmit power.
- If tuning does not finish although the SWR meter indicates smaller than 3:1, adjust the antenna system to lower the SWR, then retry tuning.
- Tuning may not lower the SWR to 1:1 depending on conditions.

PRESETTING

After each successful tuning session, the Preset function stores the position of the tuning capacitor in memory. The position of the capacitor is stored for each of the antenna tuner bands (see table below) and for each antenna connector (ANT 1 and ANT 2).

Press **[AT TUNE]** and release it immediately.

- "AT" will appear to show that the internal tuner is in-line (not bypassed).
- Each time you go across the antenna tuner band, the Preset function automatically positions the tuning capacitor without need for retuning. If no Preset data exists for a particular band/antenna combination, then the default data for 50 Ω is used.

Note: Tuning may restart to obtain the optimum matching condition although the current antenna tuner band has the preset data. This does not indicate a malfunction.

Frequency Range (MHz)	Frequency Range (MHz)
0.03 ~ 1.85	14.10 ~ 14.50
1.85 ~ 2.50	14.50 ~ 18.50
2.50 ~ 3.525	18.50 ~ 21.15
3.525 ~ 3.575	21.15 ~ 21.50
3.575 ~ 3.725	21.50 ~ 25.50
3.725 ~ 4.10	25.50 ~ 29.00
4.10 ~ 7.03	29.00 ~ 30.00
7.03 ~ 7.10	30.00 ~ 51.00 ¹
7.10 ~ 7.50	51.00 ~ 52.00 ¹
7.50 ~ 10.50	52.00 ~ 53.00 ¹
10.50 ~ 14.10	53.00 ~ 60.00 ¹

¹TS-570S only

DRU-3A DIGITAL RECORDING UNIT (OPTIONAL)

The optional DRU-3A unit allows you to record a voice message on up to 3 channels. After recording a message via your transceiver microphone, you can then send that message.

The maximum recording time for each channel is as follows:

Channel 1: Approx. 30 sec

Channel 2: Approx. 15 sec

Channel 3: Approx. 15 sec

The DRU-3A is useful in many situations:

- DX chasing or contest operation where repeated calls are necessary for extended periods of time
- Checking interference complaints to other equipment (lets you be in two places at one time)
- Checking or adjusting your transmit signal or your antenna(s) if it's not convenient to be sitting in front of your microphone
- Helping a friend adjust his antenna or receive when he needs repeated test transmissions from you

For information on how to install the DRU-3A unit, refer to "INSTALLING OPTIONS" {page 57}.

RECORDING MESSAGES

This section explains how to record a single message.

- 1 Select SSB, FM, or AM.
 - Use the same mode for transmitting and receiving.
- 2 If VOX is ON, press [VOX] to switch the function OFF.
- 3 Press [REC] to enter the Record Standby mode.
 - "AP --" appears.

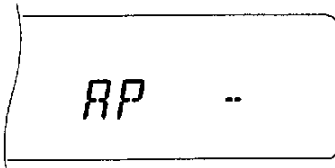

- To exit the Record Standby mode and quit recording your message, press [CLR].
- 4 Press and hold down [CH 1], [CH 2], or [CH 3] and begin speaking into your microphone.
 - There are three channels for recording messages. Press the button that corresponds to the channel that you want to use.
 - 5 Release the button pressed in step 4 when you have finished recording your message.
 - Also when the maximum recording time passes, recording stops.
 - The content of the channel is overwritten with the new message.

- 6 To record a message in another channel, start with step 3.

Note:

- To erase a message, press and hold the desired channel button, and press [CLR].
- Pressing the [POWER] switch cancels recording in progress and clears the memory channel.

MESSAGE PLAYBACK

You can play back the message in channel 1, 2, or 3 to check or to send. It is also possible to make a longer linked message, by consecutively playing back the messages of more than one channel.

You can even send a longer linked message repeatedly by using the Repeat function. To switch this function ON, access Menu No. 23 and select ON. The default is OFF.

Note:

- Pressing the [POWER] switch cancels playback in progress.
- The settings in Menu No. 23 and No. 24 are shared with CW Message Playback described in "CW MESSAGE MEMORY" (page 35).

■ Checking Messages

- 1 Select SSB, FM, or AM.
 - Use the same mode for transmitting and receiving.
- 2 If VOX is ON, press [VOX] to switch the function OFF.
- 3 Press [CH 1], [CH 2], or [CH 3], depending on which channel you want to check.
 - For example, "AP 1--" appears while playing back the message in channel 1.

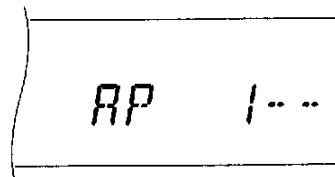

- To interrupt playback, press [CLR].
- 4 To play back another message in sequence, press the corresponding [CH 1], [CH 2], or [CH 3] while playing back the first message.
 - Up to three channels can be queued at the same time.

12 OPERATOR CONVENIENCES

■ Sending Messages

- 1 Select SSB, FM, or AM.
 - Use the same mode for transmitting and receiving.
- 2 Press **[VOX]** to switch VOX ON or OFF.
 - Depending on this selection, the subsequent procedures differ.
- 3 If you switch OFF VOX in step 2, press **[SEND]**, or press and hold Mic **[PTT]**.
- 4 Press **[CH 1]**, **[CH 2]**, or **[CH 3]**, depending on which channel you want to use.
 - For example, "AP 1--" appears while playing back the message in channel 1.

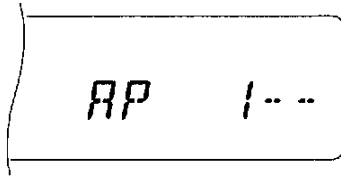

- To interrupt playback, press **[CLR]**.
- 5 To play back another message in sequence, press the corresponding **[CH 1]**, **[CH 2]**, or **[CH 3]** while playing back the first message.
 - Up to three channels can be queued at the same time.
 - 6 If you press **[SEND]** or Mic **[PTT]** in step 3, press **[SEND]** again or release Mic **[PTT]**.

■ Changing Inter-message Interval

For repetitive message playback, you can change the interval between each series of messages. Use Menu No. 24, and select the time in the range of 0 to 60 seconds.

■ Changing Volume

Turning the **AF** control does not change the volume for playback. To change the volume, use Menu No. 25.

VS-3 VOICE SYNTHESIZER (OPTIONAL)

Install the optional VS-3 unit to use this function. Each time you change the transceiver mode such as VFO A/B or Memory Recall, the transceiver automatically announces the new mode. In addition, you can program the front panel [PF] button so that pressing [PF] makes the transceiver announce the displayed information. If you have the optional MC-47 microphone, you can program one of the Mic [PF] buttons for this function.

For an explanation on how to install the VS-3 unit, refer to "INSTALLING OPTIONS" (page 57).

The table below shows what the transceiver automatically announces when it enters a new mode.

Key Pressed	New Mode	Announcement
[A/B]	VFO A	VFO A frequency
	VFO B	VFO B frequency
[M/V]	Memory Recall ¹	Channel number and frequency
QUICK MEMO [MR]	Quick Memory Recall ¹	"Q", channel number and frequency
[MENU]	Menu ¹	"MENU", menu number and menu selection
[ENT]	Entry ²	"enter"

¹ When you change the channel or menu number in this mode, the transceiver announces the new number.

² When you enter a number using the numeric keys in Entry mode or Memory Scroll mode, the transceiver announces the entered number.

For the [PF] button, the transceiver will announce different information depending on whether Voice 1 or Voice 2 is selected.

Voice 1:

- VFO or memory channel frequencies are announced beginning with the 10 MHz digit and continuing through to the 10 Hz digit. If the memory channel has no data stored, "open" is announced. For the MHz decimal point, "point" is announced. For the kHz decimal point, a short pause (200 ms) is made. A 200 ms pause also is made between the channel number and the frequency.
- Menu numbers and their settings are announced with a short pause (200 ms) between the menu number and the setting.

Note: If operating a button or a control changes the contents of the display while an announcement is in progress, the announcement is interrupted.

Voice 2:

- Peak readings for the S-meter are announced, for example, "S5" or "20dB".

Steps:

- 1 Assign Voice 1 or Voice 2 to the front panel [PF] button or, if you use the optional MC-47 microphone, one of the Mic [PF] buttons. For this method, refer to "PROGRAM FUNCTION BUTTON" (page 49).
- 2 Press the [PF] button that you programmed.
 - Announcement is made based on Voice 1 or Voice 2 selection.
 - To interrupt the announcement, press the [PF] button again.

OPTIONAL ACCESSORIES

PS-53
Regulated DC Power
Supply (22.5 A)

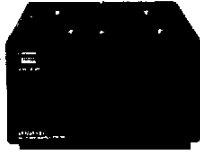

MC-43S
Hand Microphone



MC-47
Multi-function Microphone



MC-60A
Deluxe Desktop
Microphone



MC-80
Desktop Microphone



MC-85
Multi-function Desktop
Microphone



MC-90
DSP-compatible Desktop
Microphone



Microphone sensitivity is low in
FM mode.

HS-5
Deluxe Headphones



HS-6
Small Headphones



SP-23
External Speaker



SP-50B
Mobile Speaker

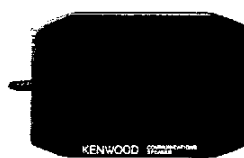

MB-430
Mobile Mounting Bracket

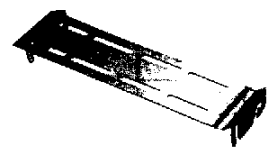

DRU-3A
Digital Recording Unit



SO-2
Temperature-
compensated Crystal
Oscillator (TCXO)



VS-3
Voice Synthesizer Unit

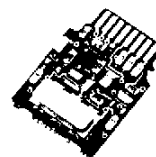

PC-1A
Phone Patch Controller



Using PC-1A with the transceiver
does not comply with the European
EMC standard.

IF-232C
Interface Unit



LF-30A
Low-pass Filter



YK-88C-1
CW Filter (500 Hz)



YK-88CN-1
CW Filter (270 Hz)

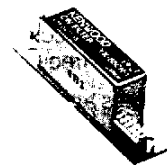

13

YK-88SN-1
SSB Filter (1.8 kHz)



PG-2Z
DC Cable



MA-5
Mobile 5-band Antenna



INSTALLING OPTIONS

The following equipment is required for installing the optional units.

- Large Philips screwdriver
- Small Philips screwdriver
- 25 W pencil soldering iron (for the SO-2 unit only)

REMOVING THE BOTTOM CASE

When installing the optional DRU-3A, VS-3, or SO-2 unit, remove the bottom case first.

- 1 Remove the 8 screws.

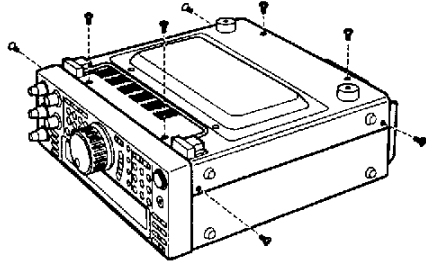

- 2 Lift off the bottom case.

DRU-3A DIGITAL RECORDING UNIT

CAUTION: SWITCH OFF THE POWER AND UNPLUG THE DC POWER CABLE BEFORE BEGINNING INSTALLATION.

- 1 Remove the bottom case (8 screws).
- 2 Remove the flat cable from the CN15 connector.

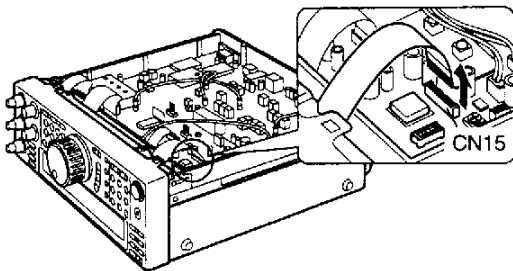

- 3 Peel off the paper backing from the cushion installed on the transceiver PC board.

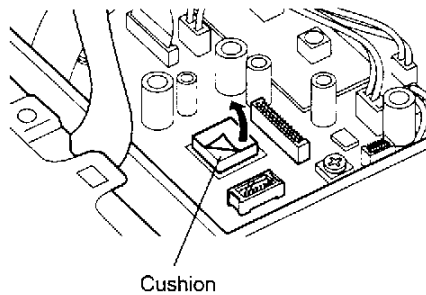

- 4 Plug the DRU-3A connector (CN901) into the CN17 connector.
- The large IC on the DRU-3A must closely contact the cushion on the PC board.

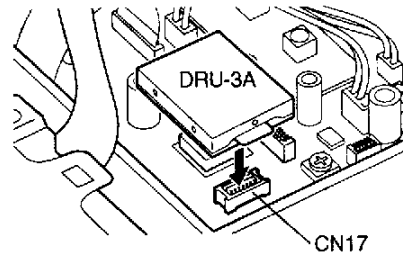

- 5 Reconnect the flat cable to the CN15 connector.
- 6 Replace the bottom case (8 screws).

14 INSTALLING OPTIONS

VS-3 VOICE SYNTHESIZER UNIT

CAUTION: SWITCH OFF THE POWER AND UNPLUG THE DC POWER CABLE BEFORE BEGINNING INSTALLATION.

- 1 Remove the bottom case (8 screws).
- 2 Hold the VS-3 unit with the component side facing inward, and insert the VS-3 connector into the transceiver CN16 connector.

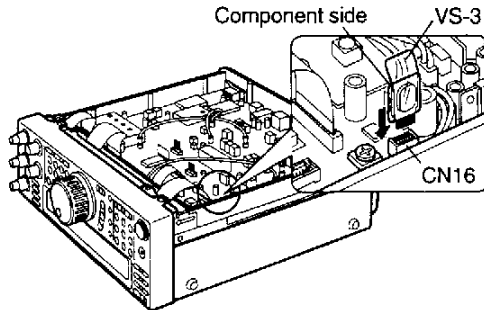

- 3 Replace the bottom case (8 screws).

Note: The VR8 allows you to adjust the volume for voice announcement. Use only when the volume level is too low or too high.

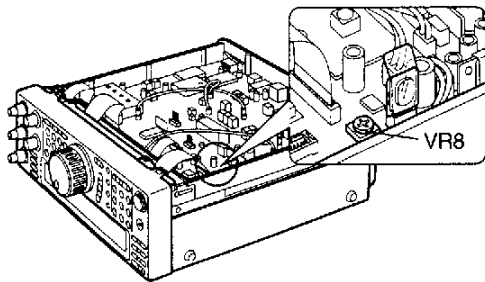

YK-88C-1/YK-88CN-1/YK-88SN-1 FILTERS

CAUTION: SWITCH OFF THE POWER AND UNPLUG THE DC POWER CABLE BEFORE BEGINNING INSTALLATION.

- 1 Remove the 2 screws from the bottom cover of the transceiver.

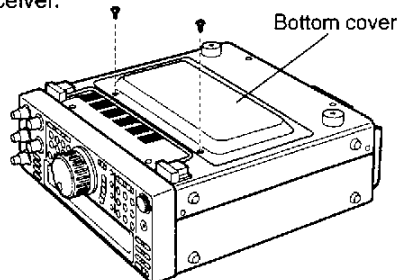

14

- 2 Remove the bottom cover.

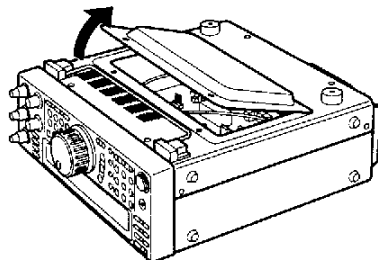

- 3 Remove the 2 screws from the OPTION FILTER section of the transceiver PC board.

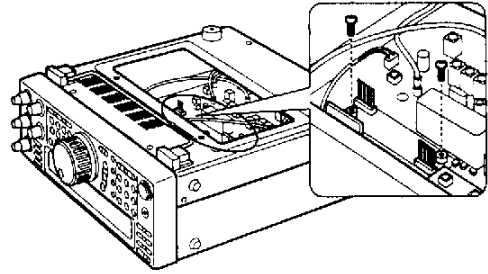

- 4 Align the pins of the transceiver CN8 and CN9 connectors with the two connectors on the filter.
 - Take care to properly align the pins.

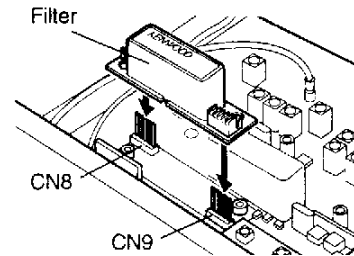

- 5 While holding the filter, carefully push down until the filter snaps into place.

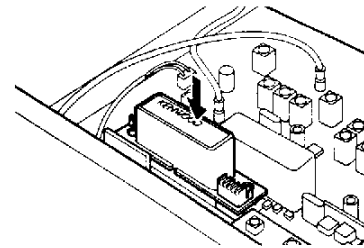

- 6 Re-install the 2 screws that you removed in step 3.
- 7 Replace the bottom cover (2 screws).

Note: After installing the filter, be sure to select the appropriate setting in Menu No. 46; otherwise the filter will not function.

SO-2 TEMPERATURE-COMPENSATED CRYSTAL OSCILLATOR (TCXO)

CAUTION: SWITCH OFF THE POWER AND UNPLUG THE DC POWER CABLE BEFORE BEGINNING INSTALLATION.

- 1 Remove the bottom case (8 screws).
- 2 Remove the protective cover installed on the PC board (6 screws).

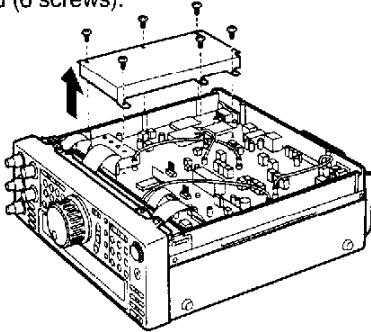

- 3 Remove the 13 screws that fasten the PC board to the chassis.

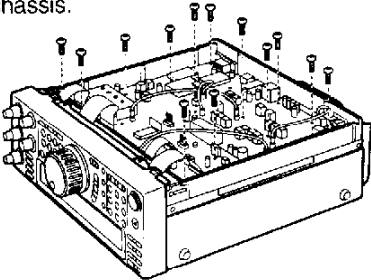

- 4 Remove the clamp that fastens the heat sink to the chassis.

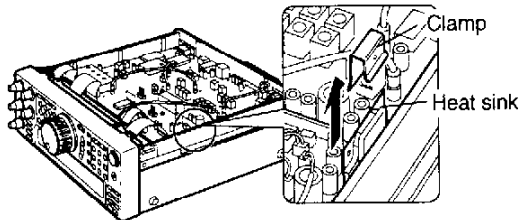

- 5 Remove the cable from the CN1 connector.

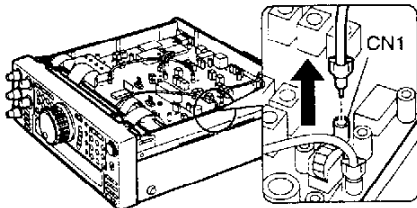

- 6 Take the CN1 connector cable off the cable holder.

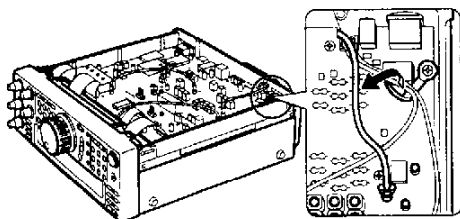

- 7 Cut the leads of the R503 and R504 resistors.

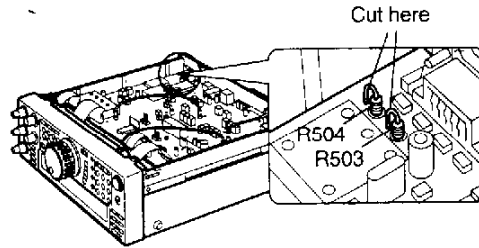

- 8 Insert the SO-2 unit into the specified position on the PC board.

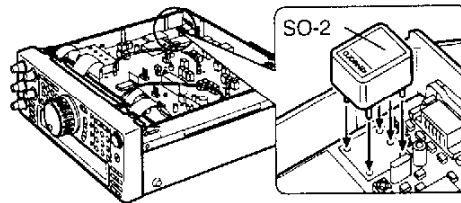

- 9 Turn the PC board over.
 - Be careful not to damage the flat cables connected to the PC board, and not to drop the SO-2 unit.

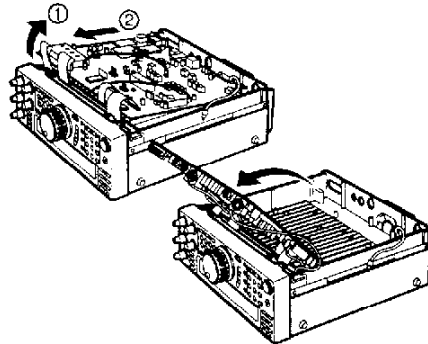

- 10 Solder the five pins of the SO-2 unit to the PC board, then cut off the SO-2 pins extruding from the PC board.

- 11 Re-position the PC board.

- 12 Re-install the 13 screws on the PC board.

- 13 Re-install the protective cover on the PC board (6 screws).

- 14 Re-position the clamp.
 - Be careful with the orientation of the clamp. See the drawing in step 4.

- 15 Reconnect the cable to the CN1 connector.

- 16 Pull the CN1 connector cable, and lock it using the cable holder.

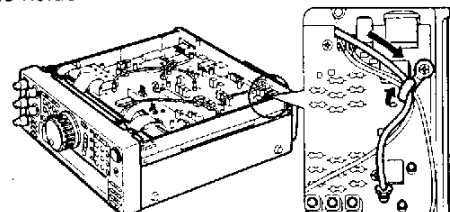

- 17 Replace the bottom case (8 screws).

CONNECTING PERIPHERAL EQUIPMENT

COMPUTER

The **COM** connector allows you to directly connect a computer or dumb terminal by using an RS-232C cable terminated with a female 9-pin connector.

No external hardware interface is required between your computer and the transceiver. See "APPENDIX" on page 70 for information related to this connector.

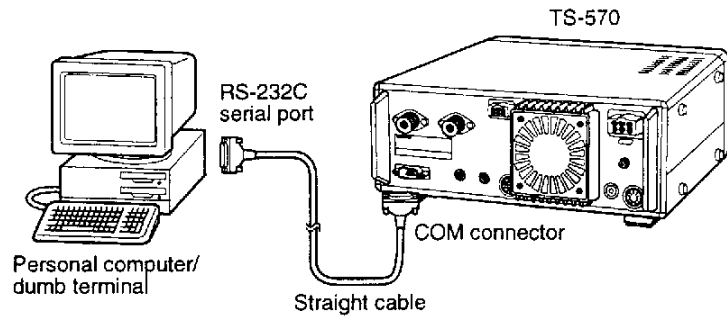

COMPATIBLE TRANSCEIVER

When transferring data to or from another TS-570 or the TS-870S, directly connect the two transceivers using the **COM** connectors.

When transferring data to other **KENWOOD** transceivers, use the optional IF-232C interface unit. Connect the IF-232C to the **ACC 1** connector located on the compatible transceiver. 6-pin DIN plugs (E07-0654-XX) are available as options. Contact your dealer or a **KENWOOD** Service Center.

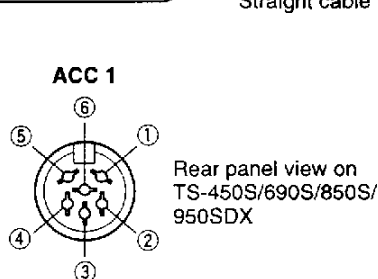
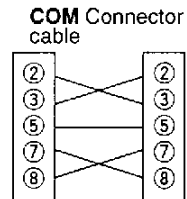
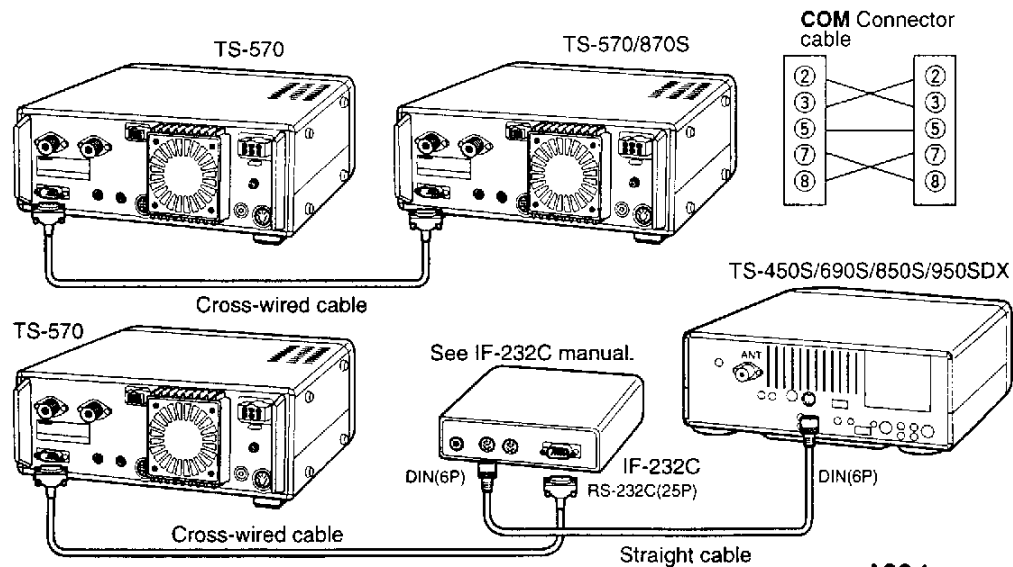

Pin No.	Pin Name
1	GND
2	TXD
3	RXD
4	CTS
5	RTS
6	NC

RTTY EQUIPMENT

Use the **ACC 2** connector to connect to the RTTY equipment. Connect the RTTY key output line to pin 2 of the **ACC 2** connector. Connect the demodulation input line of the RTTY equipment to pin 3 of the **ACC 2** connector.

Note: Do not share a single power supply between the transceiver and the RTTY equipment. Keep as wide a separation as possible between the transceiver and the RTTY equipment as practical to reduce noise-pickup by the transceiver.

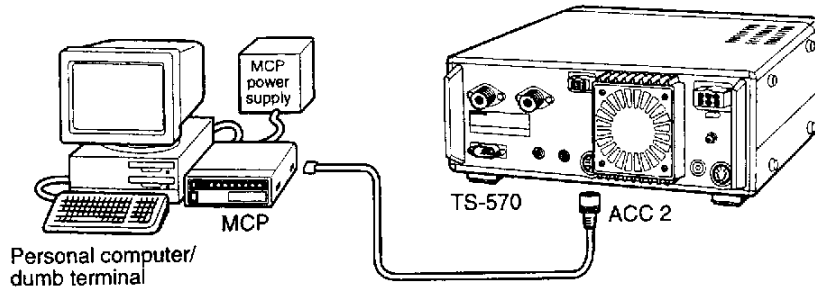

LINEAR AMPLIFIER

Connect an external transmit power amplifier to the **REMOTE** connector. Before using the external amplifier, switch ON the linear amplifier control relay via Menu No. 39.

The TX/RX relay response time is 10 ms when you have selected CW Full Break-in and 25 ms when you have selected CW Semi Break-in.

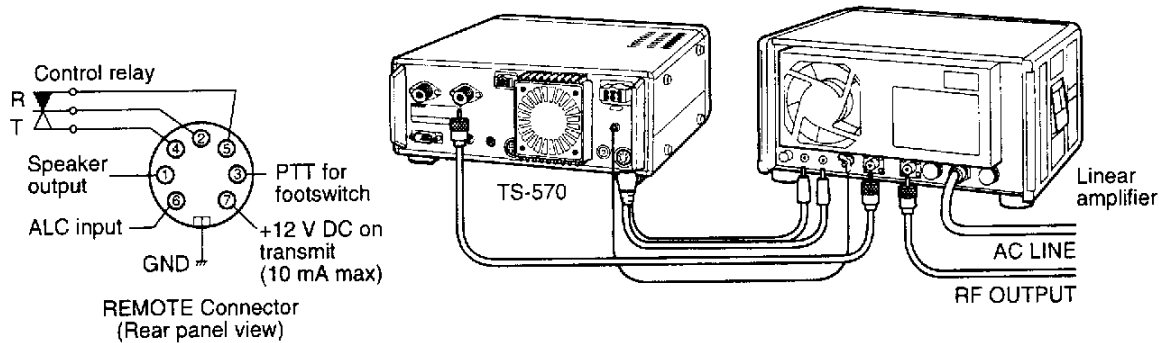

ANTENNA TUNER

Use the **ANT 1** connector and the **AT** connector to connect an external antenna tuner. If you connect the external tuner to the **ANT 2** connector, the external tuner will not function.

Note: While using an external antenna tuner with the TS-570S, you cannot use the 6 m band to transmit. Connect your 6 m band antenna to the **ANT 2** connector.

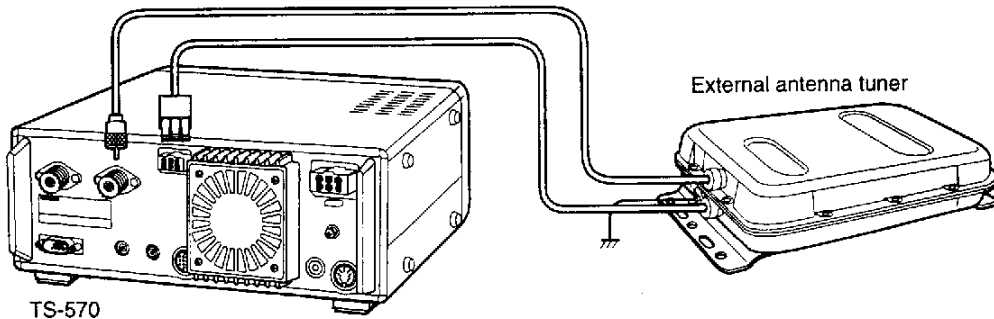

15 CONNECTING PERIPHERAL EQUIPMENT

MCP AND TNC

Use the **ACC 2** connector to connect the input/output lines from a Terminal Node Controller (TNC) for Packet operation, a Multimode Communications Processor (MCP) for operation on Packet, PacTOR, AMTOR, G-TOR™, or FAX, or from a Clover interface. Also use the **ACC 2** connector to connect SSTV and phone patch equipment.

- Connect the TNC or MCP to the **ACC 2** connector using a cable equipped with a 13-pin DIN plug.
- Connecting the TNC or MCP to a personal computer or dumb terminal requires an RS-232C cable.

Note:

- ◆ Do not share a single power supply between the transceiver and the TNC or MCP. Keep as wide a separation as possible between the transceiver and the computer as practical to reduce noise-pickup by the transceiver.
- ◆ The output voltage of Pin No. 6 (SMET) is not 0 V even when no signal is present. In addition, the output voltage differs between FM (approx. 2.8 ~ 3.8 V) and other modes (approx. 0.5 ~ 3.8 V). When connecting this pin to peripheral equipment such as a personal computer, the input impedance of that equipment must be higher than 1 MΩ. If you connect to equipment having lower impedance, the S-meter will not give accurate readings.

Pin No.	Pin Name	Function
1	NC	Not connected
2	RTK	RTTY key input
3	ANO	AF output from receiver <ul style="list-style-type: none"> • Connect to TNC or MCP receive data pin for digital operation. • AF output level is independent of AF control setting. • AF output level can be changed via Menu No. 34. • Output impedance: 4.7 kΩ
4	GND	Shield for pin 3
5	PSQ	Squelch control <ul style="list-style-type: none"> • Connect to TNC or MCP squelch control pin for digital operation. • Prevents the TNC from transmitting while the receiver squelch is open. • Squelch open: Low impedance • Squelch closed: High impedance
6	SMET	S-meter output
7	NC	Not connected
8	GND	Chassis ground
9	PKS	Transceiver PTT line control <ul style="list-style-type: none"> • Connect to TNC or MCP transmit/receive switching pin for digital operation. • Microphone audio input is muted when the transceiver is switched to the transmit mode.
10	NC	Not connected
11	PKD	Microphone audio input <ul style="list-style-type: none"> • Connect to TNC or MCP transmit data pin for digital operation.
12	GND	Shield for pin 11
13	SS	PTT control (in parallel with MIC jack) for connecting a footswitch or other external controller

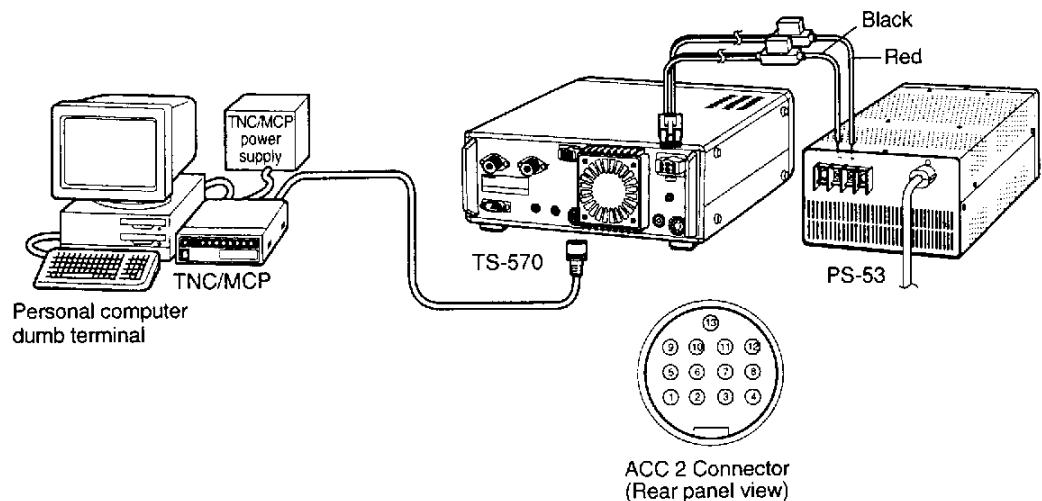

GENERAL INFORMATION

Your transceiver has been factory aligned and tested to specification before shipment. Under normal circumstances, the transceiver will operate in accordance with these operating instructions. All adjustable trimmers, coils and resistors in the transceiver were preset at the factory. They should only be readjusted by a qualified technician who is familiar with this transceiver and has the necessary test equipment. Attempting service or alignment without factory authorization can void the transceiver warranty.

When operated properly, the transceiver will provide years of service and enjoyment without requiring further realignment. The information in this section gives some general service procedures requiring little or no test equipment.

SERVICE

If it is ever necessary to return the equipment to your dealer or service center for repair, pack the transceiver in its original box and packing material. Include a full description of the problems experienced. Include both your telephone number and fax number (if available) along with your name and address in case the service technician needs to call for further explanation while investigating your problem. Don't return accessory items unless you feel they are directly related to the service problem.

You may return your transceiver for service to the authorized **KENWOOD** dealer from whom you purchased it or any authorized **KENWOOD** service center. A copy of the service report will be returned with the transceiver. Please do not send subassemblies or printed circuit boards. Send the complete transceiver.

Tag all returned items with your name and call sign for identification. Please mention the model and serial number of the transceiver in any communication regarding the problem.

SERVICE NOTE

Dear YL/OM,

If you desire to correspond on a technical or operational problem, please make your note short, complete, and to the point. Help us help you by providing the following:

- 1 Model and serial number of equipment
- 2 Question or problem you are having
- 3 Other equipment in your station pertaining to the problem
- 4 Meter readings
- 5 Other related information (Menu setup, mode, frequency, button sequence to induce malfunction, etc.)

CAUTION: DO NOT PACK THE EQUIPMENT IN CRUSHED NEWSPAPERS FOR SHIPMENT! EXTENSIVE DAMAGE MAY RESULT DURING ROUGH HANDLING OR SHIPPING.

Note:

- ◆ Record the date of purchase, serial number and dealer from whom the transceiver was purchased.
- ◆ For your own information, retain a written record of any maintenance performed on the transceiver.
- ◆ When claiming warranty service, please include a photocopy of the bill of sale, or other proof-of-purchase showing the date of sale.

CLEANING

The buttons, controls and case of the transceiver are likely to become soiled after extended use. Remove the controls from the transceiver and clean them with a neutral detergent and warm water. Use a neutral detergent (no strong chemicals) and a damp cloth to clean the case.

16 MAINTENANCE

INTERNAL ADJUSTMENTS

REFERENCE FREQUENCY CALIBRATION

Note:

- ◆ The transceiver is adjusted at the factory prior to shipping. Unless necessary, **DO NOT** perform this adjustment.
- ◆ If you have installed the optional SO-2 unit, you cannot perform this adjustment.

1 Set the following on the transceiver:

- Mode: CW
- **AF** control: Center
- Menu No. 20 (CW RX pitch): 800 Hz
- **IF SHIFT** control: Center
- Receive bandwidth {page 38}: 600 Hz
- RIT function: OFF
- Break-in function (VOX): OFF

2 Remove the bottom case (8 screws) from the transceiver.

3 Remove the protective cover installed on the PC board (6 screws).

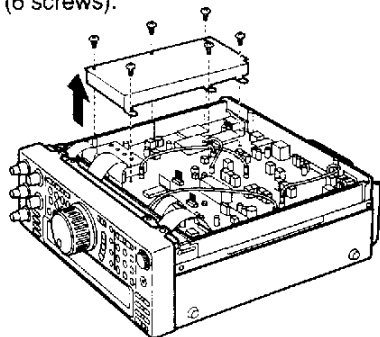

4 Tune in a standard frequency station such as WWV or WWVH at, for example, 10.000 or 15.000 MHz.

- Adjust the **Tuning** control so that the display reads the exact frequency of the station.
- You should hear a beat tone of approximately 800 Hz.
- For 800 Hz:

$$f_{\text{at}} = (f_{\text{display}}/20.000 \times \Delta f_{\text{reference}}) + 800 \text{ Hz}$$

where $\Delta f_{\text{reference}}$ is the shift from the 20 MHz reference frequency

5 Close your CW key and you will hear a transmit sidetone of approximately 800 Hz.

- This sidetone produces a double beat tone when it combines with the received signal.
- Adjust the **AF** control to hear the double beat clearly.
- For 800 Hz:
 $f_{\text{sidetone}} = 800 \text{ Hz} \pm 50 \text{ ppm} (= 800 \pm 0.04 \text{ Hz})$
where $\Delta f_{\text{reference}}$ is the shift from the 20 MHz reference frequency

6 Adjust the TC500 trimmer to minimize the frequency difference between the received 800 Hz tone and the 800 Hz sidetone.

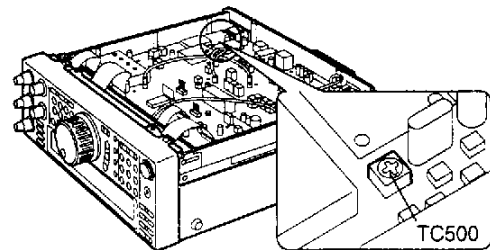

7 Re-install the protective cover on the PC board (6 screws).

8 Re-install the bottom case (8 screws).

ACCESSING THE INTERNAL FUSE

1 Remove the top case (8 screws) from the transceiver.

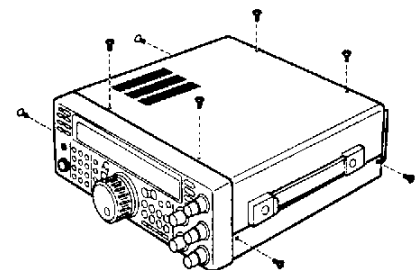

2 Remove the 12 screws that fasten the inner cover to the chassis.

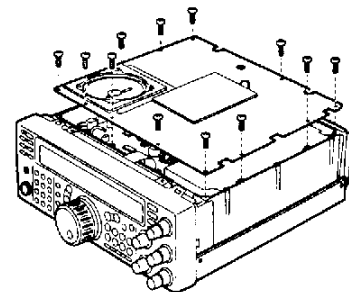

3 Open the inner cover.

- Be careful not to damage the speaker cable connected to the PC board.

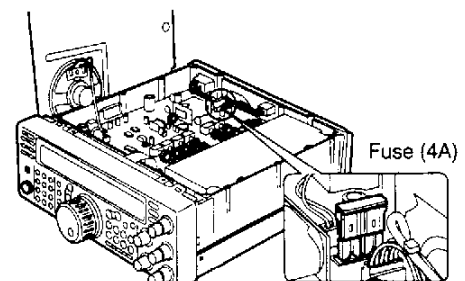

TROUBLESHOOTING

The problems described in this table are commonly encountered operational malfunctions. These types of difficulties are usually caused by improper hook-up, accidental incorrect control settings, or operator error due to incomplete programming. These problems are usually not caused by circuit failure. Please review this table, and the appropriate section(s) of this instruction manual, before assuming your transceiver is defective.

Note:

- ◆ Due to frequency relationships of some circuits in this transceiver, beat tones may be heard on the following frequencies: 10.000 MHz, 20.000 MHz and 30.000 MHz. This is not a fault.
- ◆ Placing a powered handy transceiver near this transceiver may cause noise in this transceiver.

Problem	Probable Cause	Corrective Action	Page Ref.
The transceiver will not power up after connecting a 13.8 V DC power supply and pressing [POWER]. Nothing appears on the display, and no receiver noise is heard.	1 DC power supply is OFF.	1 Switch ON the DC power supply.	13
	2 Faulty power cable	2 Inspect the power cable. Confirm polarities are correct. Red: positive (+); Black: negative (-)	2
	3 The power cable is not connected securely.	3 Confirm the connections to the DC power supply are secure.	2
	4 Power cable fuse is open.	4 Look for the cause of the blown fuse. After inspecting and correcting any problems, install a new fuse of the specified rating.	2
After switching ON the power, the transceiver does not function normally. For example, no digits or incorrect digits appear on the display.	1 The input voltage is outside 13.8 V DC $\pm 15\%$ (11.7 to 15.8 V DC).	1 Correct the input voltage or use a 12 to 16 V battery.	2
	2 The microprocessor has malfunctioned.	2 Review "MICROPROCESSOR RESET". After understanding what data will be lost, do a Partial Reset. If the problem remains, do a Full Reset.	48
After switching ON the transceiver, "14.000.00 MHz USB" appears and all data is lost; without doing Full Reset.	The backup lithium battery voltage is too low.	Have a new battery installed by your dealer or at a KENWOOD Service Center.	39
The transceiver does not respond correctly after pressing button or key combinations, or turning controls per instructions in this manual.	1 Procedures are not being followed precisely.	1 Review "WRITING CONVENTIONS FOLLOWED".	i
	2 The Frequency Lock function is ON.	2 Press [F.LOCK] to switch OFF function.	48
	3 The microprocessor and its memory need resetting.	3 Review "MICROPROCESSOR RESET". After understanding what data will be lost, do a Partial Reset. If the problem remains, do a Full Reset.	48
	4 The buttons on the transceiver are unavailable while operating the Tuning control.	4 Stop operating the Tuning control, then press the appropriate buttons.	7
The frequency cannot be changed.	The Frequency Lock function is ON.	Press [F.LOCK] to switch OFF function.	48
SSB audio quality is very poor; the high or low audio frequencies are absent.	1 The filter for digital operation is selected.	1 Change Menu No. 32 to OFF.	18
	2 The DSP SLOPE (LOW) control or DSP SLOPE (HIGH) control was incorrectly set.	2 Turn the DSP SLOPE (LOW) control counterclockwise and the DSP SLOPE (HIGH) control clockwise.	37
	3 Noise Reduction 1 or 2 is ON.	3 Press [N.R.] to switch OFF function.	38
	4 Beat Cancel is ON.	4 Press [B.C.] to switch OFF function.	38

16 MAINTENANCE

<p>No signals are received or receive sensitivity seems poor.</p>	<ol style="list-style-type: none"> 1 The SQL control is fully clockwise. 2 The Attenuator function is ON. 3 [SEND] was pressed, and the transceiver is now in transmit mode. 4 Mic [PTT] is pressed. 5 The receive bandwidth was incorrectly set. 6 The wrong antenna connector (ANT 1/ANT 2) was selected. 7 The receive preamplifier is OFF. 	<ol style="list-style-type: none"> 1 Turn the SQL control counterclockwise. 2 Press [ATT] to switch OFF function. 3 Press [SEND] to return to receive mode. 4 Release Mic [PTT]. 5 Review sections "IF FILTER" and "CHANGING RECEIVE BANDWIDTH", and set the controls accordingly. 6 Press [ANT] to select the other antenna connector. 7 Press [PRE-AMP] to switch ON function. 	<p>14 37 15 15 36,37 48 37</p>
<p>No signals are received or receive sensitivity seems poor; S-meter is reading full scale.</p>	<p>The RF control was set too low.</p>	<p>Turn the RF control fully clockwise.</p>	<p>13</p>
<p>Received signals are totally unintelligible.</p>	<p>The wrong modulation mode was selected.</p>	<p>Press [LSB/USB], [CW/FSK], or [FM/AM] to select the correct modulation mode.</p>	<p>14</p>
<p>Memory Scan will not start scanning.</p>	<ol style="list-style-type: none"> 1 The SQL control was not set correctly. 2 Less than two memory channels were unlocked. 3 Less than two memory channels were programmed. 	<ol style="list-style-type: none"> 1 Adjust the SQL control to just eliminate background noise. 2 Unlock at least two memory channels. 3 Store data in at least two memory channels. 	<p>14 44 39</p>
<p>Memory Scan will not scan one of the stored channels; the desired channel is NOT locked out.</p>	<p>With Group Scan selected, the channel you want to scan is in a different group.</p>	<p>Select the group that contains the memory channel you want to scan.</p>	<p>47</p>
<p>Program Scan will not start scanning.</p>	<p>The start and end frequencies are identical.</p>	<p>Store different start and end frequencies.</p>	<p>43</p>
<p>Tuning does not finish successfully.</p>	<p>The impedance of the coaxial cable and antenna was not matched.</p> <ul style="list-style-type: none"> • Tuning does not successfully finish depending on conditions although the SWR meter indicates smaller than 3:1. 	<p>Adjust the antenna system to lower the SWR.</p>	<p>1</p>
<p>You cannot transmit even though you press Mic [PTT] or transmissions result in no contacts.</p>	<ol style="list-style-type: none"> 1 The microphone plug was not inserted completely into the MIC connector. 2 The Transmit Inhibit function is ON. 3 CW or FSK was selected instead of a voice mode. 4 The filter for digital operation was selected. 5 The wrong antenna connector (ANT 1/ANT 2) was selected. 	<ol style="list-style-type: none"> 1 Turn OFF the power, ensure the MIC connector has no foreign objects in it, then plug in the connector. Secure the connector with the locking ring. 2 Change Menu No. 38 to OFF. 3 Press [LSB/USB] or [FM/AM] to select a voice mode. 4 Change Menu No. 32 to OFF. 5 Press [ANT] to select the other antenna connector. 	<p>3 18 14 18 48</p>

<p>Attempting to transmit results in the "HELLO" message appearing and the receive mode being restored.</p>	<ol style="list-style-type: none"> 1 The antenna was not connected correctly. 2 The impedances of the antenna and transceiver are not properly matched. 3 The input voltage is outside 13.8 V DC \pm15% (11.7 to 15.8 V DC). 4 An inappropriate DC power cable is being used. 	<ol style="list-style-type: none"> 1 Check the antenna connection. Correct as necessary. 2 Reduce the SWR of the antenna system. 3 Correct the input voltage or use a 12 to 16V battery. 4 Use the provided or an optional DC power cable. 	<p>1 1 2 2</p>
<p>The transceiver has low transmit power.</p>	<ol style="list-style-type: none"> 1 The microphone gain was set too low. 2 Poor antenna system connections are causing high SWR. 	<ol style="list-style-type: none"> 1 When in SSB or AM mode, increase the microphone gain. 2 Check antenna connections. Confirm that the antenna tuner is reporting a low SWR. 	<p>15 1</p>
<p>VOX does not operate.</p>	<p>The VOX gain was set too low.</p>	<p>Increase the gain via Menu No. 16.</p>	<p>17</p>
<p>Linear amplifier does not operate.</p>	<ol style="list-style-type: none"> 1 The linear amplifier control relay is OFF. 2 The REMOTE connector wiring is wrong or faulty. 	<ol style="list-style-type: none"> 1 Change Menu No. 39 to ON. 2 Inspect the REMOTE connector wiring and correct as necessary. 	<p>18 61</p>
<p>You cannot access and use 10 meter band repeaters.</p>	<ol style="list-style-type: none"> 1 The repeater requires a subtone frequency for access. 2 You are not operating split frequency. 	<ol style="list-style-type: none"> 1 Review "FM REPEATER OPERATION" and select the correct frequency and type of subtone. 2 You must transmit on the repeater's input frequency and receive on the repeater's output frequency. Refer to "FM REPEATER OPERATION". 	<p>24 24</p>
<p>Digital operation results in few or no connects or contacts with other stations.</p>	<ol style="list-style-type: none"> 1 Physical connections between the transceiver, computer, and TNC or MCP are incorrect, or software settings in the TNC or MCP are wrong. 2 Different transmit and receive frequencies are being used. 3 The levels between the transceiver and the TNC/MCP are incorrect. 4 Your transmitted signal or the incoming receive signal is too weak. 5 The TX delay time parameter in your TNC/MCP was incorrectly set. 	<ol style="list-style-type: none"> 1 Re-check all connections using this manual, your TNC/MCP manual, and your computer hardware manual as references. 2 Confirm that the RIT and XIT functions are switched OFF. Confirm that you are NOT operating split frequency. 3 Adjust TX and RX levels using Menu Nos. 33 and 34, and level controls on your TNC/MCP. 4 Reorient/relocate your antenna or increase your antenna gain. 5 Set the TNC/MCP TX delay time to more than 300 ms. 	<p>62 23,30, 32 18 - -</p>
<p>Attempts at controlling the transceiver by computer have failed.</p>	<ol style="list-style-type: none"> 1 Problem with the RS-232C cable that connects the computer to the transceiver. 2 Communication parameters set in your terminal program do not match transceiver parameters. 3 The serial port on your computer is not functioning correctly. 	<ol style="list-style-type: none"> 1 Check the cable and cable connections. 2 Use the same parameters in the terminal program and the transceiver. Refer to "COMMUNICATION PARAMETERS". 3 Disconnect the computer from the transceiver, and run a utility program to test the computer serial port. 	<p>60 51 -</p>

SPECIFICATIONS

		TS-570S		TS-570D		
GENERAL	Mode		J3E (LSB, USB), A1A (CW), A3E (AM), F3E (FM), F1D (FSK)			
	Number of memory channels		100			
	Antenna impedance		50 Ω (with Antenna Tuner 16.7 ~ 150 Ω)			
	Supply voltage		DC 13.8 V ± 15%			
	Grounding method		Negative ground			
	Current	Transmit (max.)	20.5 A			
		Receive (no signal)	2 A			
	Usable temperature range		-10°C ~ 50°C (+14°F ~ 122°F)			
	Frequency stability (-10°C ~ 50°C)		Within ±10 PPM			
	Frequency accuracy (at room temperature)		Within ±10 PPM			
	Dimensions [W x H x D] (Projections included)		270 x 96 x 271 mm / 10.6 x 3.8 x 10.7 in. (281 x 107 x 314 mm / 11.1 x 4.2 x 12.4 in.)			
	Weight		Approx. 6.8 kg (15 lbs)			
	TRANSMITTER	Frequency range	160 m band		1.8 ¹ ~ 2.0 ² MHz	
80 m band			3.5 ~ 4.0 ³ MHz			
40 m band			7.0 ~ 7.3 ⁴ MHz			
30 m band			10.1 ~ 10.15 MHz			
20 m band			14.0 ~ 14.35 MHz			
17 m band			18.068 ~ 18.168 MHz			
15 m band			21.0 ~ 21.45 MHz			
12 m band			24.89 ~ 24.99 MHz			
10 m band			28.0 ~ 29.7 MHz			
6 m band			50.0 ~ 54.0 MHz		—	
Output power ⁵		SSB, CW, FSK, FM	Max.	100 W		
			Min.	5 W		
		AM	Max.	25 W		
			Min.	5 W		
Modulation		SSB		Balanced		
		FM		Reactance		
		AM		Low level		
Spurious emissions	1.8 ~ 29.7 MHz		-50 dB or less			
	50 ~ 54 MHz		-60 dB or less			
Carrier suppression		40 dB or more				
Unwanted sideband suppression (modulation frequency 1.0 kHz)		40 dB or more				
Maximum frequency deviation (FM)	Wide		±5 kHz or less			
	Narrow		±2.5 kHz or less			
XIT shift frequency range		±9.99 kHz				
Microphone impedance		600 Ω				

¹ 1.81 MHz: Europe, France, Holland; 1.83 MHz: Belgium, Spain

² 1.85 MHz: France, Holland, Belgium, Spain

³ 3.8 MHz: Europe, France, Holland, Belgium, Spain

⁴ 7.1 MHz: Europe, France, Holland, Belgium, Spain

⁵ Belgium, Spain: 10 W fixed on 160 m band

		TS-570S		TS-570D		
RECEIVER	Circuit type		Double conversion superheterodyne FM only: Triple conversion superheterodyne			
	Frequency range		500 kHz ~ 60 MHz		500 kHz ~ 30 MHz	
	Intermediate frequency		1st: 73.05 MHz; 2nd: 8.83 MHz; 3rd: 455 kHz (FM only)			
	Sensitivity	SSB, CW, FSK (at 10 dB (S+N)/N)	500 kHz ~ 1.705 MHz	4 μ V or less		
			1.705 MHz ~ 24.5 MHz	0.2 μ V or less		
			24.5 MHz ~ 30 MHz	0.13 μ V or less		
			50 MHz ~ 54 MHz	0.13 μ V or less	—	
		AM (at 10 dB (S+N)/N)	500 kHz ~ 1.705 MHz	31.6 μ V or less		
			1.705 MHz ~ 24.5 MHz	2 μ V or less		
			24.5 MHz ~ 30 MHz	1.3 μ V or less		
			50 MHz ~ 54 MHz	1.3 μ V or less	—	
		FM (at 12 dB SINAD)	28 MHz ~ 30 MHz	0.25 μ V or less		
			50 MHz ~ 54 MHz	0.25 μ V or less	—	
	Selectivity	SSB, CW, FSK		-6 dB: 2.2 kHz, -60 dB: 4.4 kHz		
		AM		-6 dB: 4 kHz, -50 dB: 20 kHz		
		FM		-6 dB: 12 kHz, -50 dB: 25 kHz		
	Image rejection	1.8 MHz ~ 30 MHz		70 dB or more		
		50 MHz ~ 54 MHz		70 dB or more	—	
	1st IF rejection	1.8 MHz ~ 30 MHz		70 dB or more		
		50 MHz ~ 54 MHz		70 dB or more	—	
RIT shift frequency range		\pm 9.99 kHz				
Squelch sensitivity	SSB, CW, FSK, AM	500 kHz ~ 1.705 MHz	20 μ V or less			
		1.705 MHz ~ 30 MHz	2 μ V or less			
		50 MHz ~ 54 MHz	2 μ V or less	—		
	FM	28 ~ 30 MHz	0.25 μ V or less			
		50 MHz ~ 54 MHz	0.25 μ V or less	—		
Audio output (8 Ω , 10% distortion)		1.5 W or more				
Audio output impedance		8 Ω				

Specifications are subject to change without notice or obligation due to ongoing technological developments.

APPENDIX: COM CONNECTOR PROTOCOL

HARDWARE DESCRIPTION

This transceiver uses a full-duplex, asynchronous, serial interface for communicating through the male 9-PIN RS-232C **COM** connector. Bytes are constructed with 1 start bit, 8 data bits, and 1 stop bit (4800 bps can be configured for 1 or 2 stop bits). No parity is used. The pinout and the pin functions of the **COM** connector are as shown below:

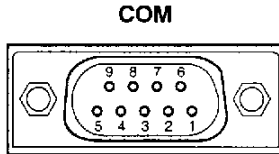

COM Pin No.	COM Pin Name (Ref.: Computer)	Function (Ref.: Transceiver)	I/O
1	NC	—	—
2	RXD	Transmit data	Output
3	TXD	Receive data	Input
4	NC	—	—
5	GND	Signal ground	—
6	NC	—	—
7	RTS	Receive enable	Input
8	CTS	Transmit enable	Output
9	NC	—	—

RXD: Transmit data is serial data transferred from the transceiver to the computer.

TXD: Receive data is serial data transferred from the computer to the transceiver.

GND: Signal ground pin

RTS: This signal is applied to the transceiver. It is used to inhibit transmit data from the transceiver when the computer is not ready to receive the data. Transmit data is inhibited when the level is low.

CTS: This signal is applied from the transceiver. It is used to inhibit transmit data from the computer when the transceiver is not ready to receive the data. Transmit data is stopped when the level is low.

CONTROL OPERATION

Most computers handle data in the form of "bits" and "bytes". A bit is the smallest piece of information that the computer can handle. A byte is composed of eight bits. This is the most convenient form for most computer data. This data may be sent in the form of either serial or parallel data strings. The parallel method is faster but more complicated, while the serial method is slower and requires less complicated equipment. The serial form is, therefore, a less expensive alternative.

Serial data transmission uses time-division methods over a single line. Using a single line also offers the advantage of reducing the number of errors due to line noise.

Only 3 lines are required theoretically for control of the transceiver via the computer:

- Transmit data
- Receive data
- Ground

From a practical standpoint, it is also necessary to incorporate some means of controlling when this data transfer will occur. The computer and transceiver cannot be allowed to send data at the same time! The required control is achieved by using the RTS and CTS lines.

For example, the transceiver is placed into the transmit mode whenever the character string "TX;" is sent from the computer. The character string "TX;" is called a computer control command. It tells the transceiver what to do. There are numerous commands available for control of the transceiver. These commands may be incorporated into a computer program written in any high level language. Programming methods vary from computer to computer; therefore, refer to the instruction manuals provided with the terminal program and computer.

COMPUTER CONTROL COMMANDS

A computer control command is composed of an alphabetical command, various parameters, and the terminator that signals the end of the control command.

EXAMPLE: Command to set VFO A to 7 MHz

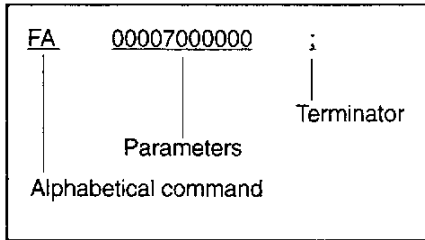

Commands can be classified as shown below:

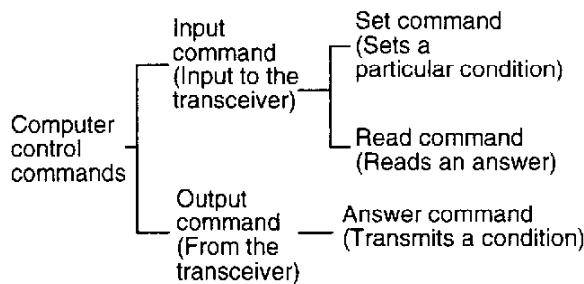

For example, note the following in the case of the FA command (Frequency of VFO A):

- To set the frequency to 7 MHz, the following command is sent from the computer to the transceiver:
 "FA00007000000;" **(Set command)**
- To read the frequency of VFO A, the following command is sent from the computer to the transceiver:
 "FA;" **(Read command)**
- When the Read command above has been sent, the following command is returned to the computer:
 "FA00007000000;" **(Answer command)**

Note:

- Do not use the control characters 00 to 1Fh since they are either ignored or cause a "?" answer.
- Program execution may be delayed while turning the Tuning control rapidly.
- Receive data is not processed if the frequency is entered from the keypad.

Alphabetical Commands

A command consists of 2 alphabetical characters. You may use either lower or upper case characters. The commands available for this transceiver are listed in the Alphabetical Command Table {page 72}.

Parameters

Parameters are used to specify information necessary to implement the desired command. The parameters to be used for each command are predetermined. The number of digits assigned to each parameter is also predetermined. Refer to the Parameter Table (page 73) and the Computer Control Command Tables (page 75) to configure the appropriate parameters.

When configuring parameters, be careful not to make the following mistakes.

(correct parameter: "IS+1000")

- IS1000; Not enough parameters specified (No direction given for the IF shift)
- IS+100; Not enough digits (Only three frequency digits given)
- IS _ + _ 1000; Unnecessary characters between parameters
- IS+10000; Too many digits (Five frequency digits given)

Note: If a particular parameter is not applicable to this transceiver, the parameter digits should be filled using any character except the ASCII control codes (00 to 1Fh) and the terminator (;).

Terminator

To signal the end of a command, it is necessary to use a semicolon (;). The digit where this special character must appear differs depending on the command used.

Error Messages

In addition to the Answer command, the transceiver can send the following error messages.

Error Message	Reason for Error
?	<ul style="list-style-type: none"> Command syntax was incorrect. Command was not executed due to the current status of the transceiver (even though the command syntax was correct). <p><i>Note: Occasionally this message may not appear due to microprocessor transients in the transceiver.</i></p>
E;	A communication error occurred such as an overrun or framing error during a serial data transmission.
O;	Receive data was sent but processing was not completed.

■ Alphabetical Command Table

Command	Function
AC	Antenna Tuner THRU/IN-LINE, and tuning START/CANCEL
AG	Sets or reads AF gain.
AI	Auto information
AN	Selects antenna connector (ANT 1/ANT 2).
BC	Sets or reads Beat Cancel.
BY	Reads busy signals.
CA	Sets or reads CW Auto Zero-beat (OFF/ON).
CN	Sets or reads CTCSS tone number (01~39).
CT	Sets or reads CTCSS (OFF/ON).
DN	MIC DOWN function
EX	Sets or reads Menu.
FA	Sets or reads VFO A frequency.
FB	Sets or reads VFO B frequency.
FR	Sets RX (VFO A/B, memory channel).
FS	Fine function (OFF/ON)
FT	Sets TX (VFO A/B, memory channel).
FW	Sets or reads filter bandwidth.
GT	Sets or reads AGC time constant.
ID	Reads model number of the transceiver.
IF	Reads status of the transceiver.
IS	Sets or reads IF shift.
KS	Sets or reads keying speed while using the KY command or the built-in keyer.
KY	Converts input characters into Morse code.
LK	Sets or reads Frequency Lock (OFF/ON).
LM	DRU or CW message recording
MC	Sets or reads memory channels.
MD	Sets or reads modulation modes.
MG	Sets or reads MIC gain.
MR	Reads memory.
MW	Writes into memory.
NB	Sets or reads Noise Blanker (OFF/ON).
NR	Sets or reads Noise Reduction.
PA	Sets or reads Preamplifier (OFF/ON).

Command	Function
PB	DRU or CW message playback
PC	Sets or reads transmit power.
PR	Sets or reads Speech Processor (OFF/ON).
PS	Sets or reads power (OFF/ON).
PT	Sets or reads CW RX pitch.
RA	Sets or reads RF ATT (attenuator).
RC	Clears RIT frequency.
RD	Lowers RIT frequency.
RG	Sets or reads RF gain.
RM	Selects a meter function or reads meter values.
RT	Sets or reads RIT (OFF/ON).
RU	Raises RIT frequency.
RX	Selects receive mode.
SC	Sets or reads Scan (OFF/ON).
SD	Sets or reads Semi Break-in delay time.
SH	Sets or reads high cut-off frequency.
SL	Sets or reads low cut-off frequency.
SM	Reads S-meter.
SQ	Sets or reads squelch level.
SR	Resets the transceiver.
TN	Sets or reads subtone number (01~39).
TO	Sets or reads Subtone (OFF/ON).
TX	Selects transmit mode.
UP	MIC UP function
VD	Sets or reads VOX delay time.
VG	Sets or reads VOX gain.
VR	Triggers the Voice Synthesizer for message output.
VX	Sets VOX (OFF/ON).
XT	Sets XIT (OFF/ON).

■ Parameter Table

Form No.	Name	No. of Digits	Format
1	SW	1	0: OFF 1: ON
2	MODE	1	0: No selection 5: AM 1: LSB 6: FSK 2: USB 7: CW-R 3: CW 8: No selection 4: FM 9: FSK-R
3	FUNCTION	1	0: VFO A 1: VFO B 2: Memory
4	FREQUENCY	11	Represented in Hz. Ex.: 00014230000 is 14.230 MHz
5	RIT/XIT FREQUENCY	5	The first digit is "+" or "-", and the remaining four digits indicate the frequency in Hz. Ex.: +5320 is +5.32 kHz
7	MEMORY CHANNEL	2	Represented using 00-99.
9	MEMORY CHANNEL SPLIT DATA	1	0: Receive (Start freq.) 1: Transmit (End freq.) (Start/End freq.: Ch.90-99)
10	MEMORY LOCKOUT	1	0: Not locked out 1: Locked out
11	TX/RX	1	0: Receive 1: Transmit
14	STONE NUMBER	2	Represents the tone number (01-39). See the subtone frequency table on page 25.
16	MODEL NUMBER	3	Represents the type of transceiver. TS-570S: 018 TS-570D: 017
22	METER VALUE	4	RM command: 0000-0008 SM command: 0000-0015 Relative values are output.
24	METER SWITCH	1	0: No selection 1: SWR 2: COMP 3: ALC
27	PLAYBACK CHANNEL	1	0: No playback A Set command cancels playback. 1: Channel 1 2: Channel 2 3: Channel 3
30	ANTENNA TUNER	1	0: Antenna tuner thru 1: Antenna tuner in-line
31	GAIN	3	Represented using 000 (min.)-255 (max.). MG command: 000-100
32	AI NUMBER	1	0: AI OFF 1: IF command outputs its Answer command periodically. 2: For parameter changes, the corresponding Answer command is output. 3: Both 1 a 2.

Form No.	Name	No. of Digits	Format
33	ANTENNA NUMBER	1	1: ANT 1 2: ANT 2
35	MENU NUMBER	3	Represented using 000-046.
36	MENU SELECTION	4	See table on page 74.
38	FILTER WIDTH	4	Represented using 0000-9999.
39	AGC TIME CONSTANT	3	002: Fast 004: Slow
40	IF SHIFT DIRECTION	1	"+": Upward freq. shift (or "⏏") "-": Downward freq. shift
41	IF SHIFT FREQUENCY	4	Represented in Hz using 0000-1100.
42	KEYER SPEED	3	Represented in words per minute using 010 (min.)-060 (max.).
43	KEYER MESSAGE	24	Contains the CW message.
44	KEYER BUFFER	1	0: Buffer space available 1: Buffer space not available
45	LOAD MESSAGE	1	0: Not recording. A Set command cancels recording. 1: Channel 1 2: Channel 2 3: Channel 3
46	LEVEL	3	Represented using 000 (min.)-255 (max.).
47	POWER CONTROL	3	Represented in watts using 005-100, 5 W steps.
49	SEMI BREAK-IN DELAY TIME	4	Represented in msec using 0000-1000, 50 ms steps.
50	SYSTEM RESET	1	1: Partial Reset ([A/B]+ POWER ON) 2: Full Reset ([A=B]+ POWER ON)
51	VOX DELAY TIME	4	Represented in msec using 0000-3000.
52	CW RX PITCH	2	Represented using 00 (400 Hz min.) ~ 12 (1000 Hz max.).
53	DSP SLOPE	2	Represented using 00-20 High cut-off 00: 5.0 kHz 20: 1.0 kHz Low cut-off 00: 10 Hz 20: 1000 Hz
54	VOX GAIN	3	Represented using 001 (min.) ~ 009 (max.).
55	VOICE RECALL	1	1: Voice 1 2: Voice 2
56	NOISE REDUCTION	1	0: Noise Reduction OFF 1: Noise Reduction 1 2: Noise Reduction 2

● APPENDIX

■ Menu Selection Table for "EX" Command

Menu No.	Menu Item	Parameter												
		0000	0001	0002	0003	0004	0005	0006	0007	0008	0009	0010	0011	0012
00	Display brightness	OFF	d4	d3	d2	d1								
01	Beep output level	OFF	1	2	3	4	5	6	7	8	9			
02	[UP]/[DOWN]	100	500	1000										
03	MULTI/CH control (SSB/CW/FSK/AM)	1	5	10										
04	MULTI/CH control (FM)	1	5	10	12.5	20	25							
05	MULTI/CH control (rounds off freq.)	OFF	ON											
06	MULTI/CH control (AM broadcast band)	10	9											
07	Memory-VFO split	OFF	ON											
08	Tunable/fixed freq.	OFF	ON											
09	Program Scan Hold	OFF	ON											
10	Scan resume	TO	CO											
11	Antenna tuner in RX mode	OFF	ON											
12	NR2 Time constant	7.5	20											
13	TX filter (SSB/AM)	2.4	2.0											
14	TX equalizer	OFF	HB	FP	BB	C								
15	Speech processor	0	5	10	15	20	25							
16	VOX gain	0	1	2	3	4	5	6	7	8	9			
17	MIC gain (FM)	Low	High											
18	Subtone freq.	Subtone frequency Nos. 01-39: 0001-0039												
19	Subtone type	B	C											
20	CW RX pitch/ TX sidetone	400	450	500	550	600	650	700	750	800	850	900	950	1000
21	TX sidetone volume	OFF	1	2	3	4	5	6	7	8	9			
22	Semi-automatic key	OFF	ON											
23	Playback repeat	OFF	ON											
24	Playback repeat interval	0-60 sec: 0000-0060												
25	Playback volume	OFF	1	2	3	4	5	6	7	8	9			
26	Auto weighting	OFF	ON											
27	Auto weighting reversed	OFF	ON											
28	Keying priority over playback	OFF	ON											
29	FSK shift	170	200	425	850									
30	FSK polarity	OFF	ON											
31	FSK tone freq.	1275	2125											
32	Digital operation filter	OFF	1200	300	PSK									
33	AF input level (MCP/TNC TX)	0	1	2										
34	AF output level (MCP/TNC RX)	0	1	2	3	4	5	6	7	8	9			
35	COM communication parameters	12-1	24-1	48-1	48-2	96-1	192-1	384-1	576-1					
36	Data transfer enable	OFF	ON											
37	Data transfer method	OFF	ON											
38	TX inhibit	OFF	ON											
39	Linear amplifier relay	OFF	ON											
40	Transverter	OFF	50	144	430									
41	[PF]	Menu Nos. 00-40: 0000-0040												
42	Mic [PF1]	Function Nos. 50-52: 0050-0052												
43	Mic [PF2]	Function Nos. 60-76: 0060-0076												
44	Mic [PF3]	OFF: 0099												
45	Mic [PF4]													
46	IF filter	OFF	1800	500	270									

READING COMMAND TABLES

①	AC	ANTENNA TUNER CONTROL	②	⑦	⑧	⑨	⑩																								
③	Function	Antenna Tuner THRU/IN -LINE, and tuning START/CANCEL				Parameter	Format	Parameter function																							
						P1	30	TUNE THRU/IN (Answer Only)																							
						P2	30	TUNE THRU/IN																							
④	Set	1 2 3 4 5 6 7 8 9 10 11 12 13 14														⑤	Read	1 2 3 4 5 6 7 8 9 10 11 12 13 14													
		A C P2 P3 ;																A C ;													
⑥	Output Answer	1 2 3 4 5 6 7 8 9 10 11 12 13 14														Note: P1 is used for Answer only. Tuning cannot be started if P2 is in the THRU state (if P2="0", selecting '1' for P3 does not start tuning). P1: RX THRU/IN P2: TX THRU/IN															
		A C P1 P2 P3 ;																													

- ① Command
- ② Name
- ③ Function of the command
- ④ The format of the Set command is shown. When oblique lines are drawn in the 1st and 2nd columns, there is no Set command.
- ⑤ The format of the command for reading the transceiver's current status is shown. When oblique lines are drawn in the 1st and 2nd columns, there is no Read command.
- ⑥ The format of the command output from the transceiver is shown. When oblique lines are drawn in the 1st and 2nd columns, there is no Answer command.
- ⑦ The number of command digits is shown.
- ⑧ Corresponds to the parameter of the command format.
- ⑨ Corresponds to the Format number in the Parameter Table. For the parameter formats, refer to the Parameter Table (page 73).
- ⑩ Indicates the function of the parameter.

COMPUTER CONTROL COMMAND TABLES

Note: Parameters that have a Parameter Function of "NOT USED" are not supported by this transceiver. Any character except the ASCII control codes (00 to 1Fh) and the terminator (;) may be entered for those parameters.

AC ANTENNA TUNER CONTROL

Function	Antenna Tuner THRU/IN -LINE, and tuning START/CANCEL														Parameter	Format	Parameter function													
															P1	30	TUNE THRU/IN (Answer Only)													
															P2	30	TUNE THRU/IN													
Set	1 2 3 4 5 6 7 8 9 10 11 12 13 14														Input	Read	1 2 3 4 5 6 7 8 9 10 11 12 13 14													
	A C P2 P3 ;																A C ;													
Output Answer	1 2 3 4 5 6 7 8 9 10 11 12 13 14														Note: P1 is used for Answer only. Tuning cannot be started if P2 is in the THRU state (if P2="0", selecting '1' for P3 does not start tuning). P1: RX THRU/IN P2: TX THRU/IN															
	A C P1 P2 P3 ;																													

AI AUTO INFORMATION

Function	Auto information OFF/ON														Parameter	Format	Parameter function													
															P1	32	AI NUMBER													
															Note: For other commands, controls whether changing a parameter will or will not trigger the corresponding Answer command to be output.															
Set	1 2 3 4 5 6 7 8 9 10 11 12 13 14														Input	Read	1 2 3 4 5 6 7 8 9 10 11 12 13 14													
	A P1 ;																A I ;													
Output Answer	1 2 3 4 5 6 7 8 9 10 11 12 13 14														Ex: For IF, the Answer command is output if the step frequency or RIT/XIT frequency is changed. Switching the transceiver ON restores '0'.															
	A P1 ;																													

AG AF GAIN

Function	Sets or reads AF gain.														Parameter	Format	Parameter function													
															P1	31	AF GAIN													
Set	1 2 3 4 5 6 7 8 9 10 11 12 13 14														Input	Read	1 2 3 4 5 6 7 8 9 10 11 12 13 14													
	A G P1 ;																A G ;													
Output Answer	1 2 3 4 5 6 7 8 9 10 11 12 13 14																													
	A G P1 ;																													

AN ANTENNA NUMBER

Function	Selects antenna connector ANT 1/ ANT 2.														Parameter	Format	Parameter function													
															P1	33	ANTENNA NUMBER													
Set	1 2 3 4 5 6 7 8 9 10 11 12 13 14														Input	Read	1 2 3 4 5 6 7 8 9 10 11 12 13 14													
	A N P1 ;																A N ;													
Output Answer	1 2 3 4 5 6 7 8 9 10 11 12 13 14																													
	A N P1 ;																													

● APPENDIX

BC BEAT CANCEL

Function	Sets or reads Beat Cancel.														Parameter	Format	Parameter function	
															P1	1	BEAT CANCEL OFF/ON	
Input	Set	1	2	3	4	5	6	7	8	9	10	11	12	13	14			
	Read	B	C	P1														
Output	Set	1	2	3	4	5	6	7	8	9	10	11	12	13	14			
	Read	B	C	P1														

DN UP DOWN/UP

Function	Microphone DOWN/UP function.														Parameter	Format	Parameter function	
Input	Set	1	2	3	4	5	6	7	8	9	10	11	12	13	14			
	Read	DN	UP															
Output	Set	1	2	3	4	5	6	7	8	9	10	11	12	13	14			
	Read	DN	UP															

BY BUSY

Function	Reads busy signals.														Parameter	Format	Parameter function	
															P1	1	BUSY OFF/ON	
Input	Set	1	2	3	4	5	6	7	8	9	10	11	12	13	14			
	Read	B	Y															
Output	Set	1	2	3	4	5	6	7	8	9	10	11	12	13	14			
	Read	B	Y	P1														

EX EXTENSION MENU

Function	Sets or reads Menu.														Parameter	Format	Parameter function	
															P1	35	MENU NUMBER	
Input	Set	1	2	3	4	5	6	7	8	9	10	11	12	13	14			
	Read	E	X	P1	P2													
Output	Set	1	2	3	4	5	6	7	8	9	10	11	12	13	14			
	Read	E	X															

CA CW AUTO ZERO-BEAT

Function	Sets CW Auto Zero-Beat OFF/ON or reads status.														Parameter	Format	Parameter function	
															P1	1	CW AUTO ZERO-BEAT OFF/ON	
Input	Set	1	2	3	4	5	6	7	8	9	10	11	12	13	14			
	Read	C	A	P1														
Output	Set	1	2	3	4	5	6	7	8	9	10	11	12	13	14			
	Read	C	A	P1														

FA FB FREQUENCY VFO A/ VFO B

Function	Sets or reads VFO A/ VFO B frequency.														Parameter	Format	Parameter function	
															P1	4	FREQUENCY	
Input	Set	1	2	3	4	5	6	7	8	9	10	11	12	13	14			
	Read	F	A/B															
Output	Set	1	2	3	4	5	6	7	8	9	10	11	12	13	14			
	Read	F	A/B															

CN CTCSS TONE NUMBER

Function	Sets or reads CTCSS tone number(01-39).														Parameter	Format	Parameter function	
															P1	14	CTCSS TONE NUMBER	
Input	Set	1	2	3	4	5	6	7	8	9	10	11	12	13	14	Note: Selecting No. 39 (1750 Hz) switches OFF the CTCSS.		
	Read	C	N	P1														
Output	Set	1	2	3	4	5	6	7	8	9	10	11	12	13	14			
	Read	C	N	P1														

FR FT FUNCTION RX, FUNCTION TX

Function	Sets RX/TX (VFO A/B, memory channel).														Parameter	Format	Parameter function	
															P1	3	FUNCTION	
Input	Set	1	2	3	4	5	6	7	8	9	10	11	12	13	14	Note: Using FR command always places the transceiver to simplex-operation status.		
	Read	F	R/T	P1														
Output	Set	1	2	3	4	5	6	7	8	9	10	11	12	13	14			
	Read	F	R/T															

CT CTCSS FUNCTION

Function	Sets or reads CTCSS OFF/ON status.														Parameter	Format	Parameter function	
															P1	1	CTCSS OFF/ON	
Input	Set	1	2	3	4	5	6	7	8	9	10	11	12	13	14			
	Read	C	T	P1														
Output	Set	1	2	3	4	5	6	7	8	9	10	11	12	13	14			
	Read	C	T	P1														

FS FINE STEP

Function	Fine function OFF/ON														Parameter	Format	Parameter function	
															P1	1	FINE OFF/ON	
Input	Set	1	2	3	4	5	6	7	8	9	10	11	12	13	14			
	Read	F	S	P1														
Output	Set	1	2	3	4	5	6	7	8	9	10	11	12	13	14			
	Read	F	S	P1														

● APPENDIX

MC MEMORY CHANNEL

Function	Sets or reads memory channels.														Parameter	Format	Parameter function
															P1	-	NOT USED
															P2	7	MEMORY CHANNEL
Input	Set																
	M C P2																
Input	Read																
	M C																
Output	Set																
	M C P2																
Output	Read																
	M C																

MW MEMORY WRITE

Function	Writes into memory.																												Parameter	Format	Parameter function
																													P1	9	SPLIT DATA
																													P2	-	NOT USED
Input	Set																														
	M W P1 P3 P4																														
Input	Read																														
	P5 P6 P7 P8																														
Output	Set																														
	P5 P6 P7 P8																														
Output	Read																														
	P5 P6 P7 P8																														

Note: All parameters must be entered. The memory channel becomes a vacant channel if all frequency digits are '0'. Other parameters are ignored. P1 must be '0' to store a Start frequency and '1' to store an End frequency.

MD MODE

Function	Sets or reads modulation modes.														Parameter	Format	Parameter function
															P1	2	MODE
Input	Set																
	M O P1																
Input	Read																
	M O																
Output	Set																
	M O P1																
Output	Read																
	M O																

NB NOISE BLANKER

Function	Sets Noise Blanker OFF/ON or reads status.														Parameter	Format	Parameter function
															P1	1	NOISE BLANKER OFF/ON
Input	Set																
	N B P1																
Input	Read																
	N B																
Output	Set																
	N B P1																
Output	Read																
	N B																

MG MIC GAIN

Function	Sets or reads MIC gain.														Parameter	Format	Parameter function
															P1	31	MIC GAIN
Input	Set																
	M G P1																
Input	Read																
	M G																
Output	Set																
	M G P1																
Output	Read																
	M G																

NR NOISE REDUCTION

Function	Sets Noise Reduction OFF/ON or reads status.														Parameter	Format	Parameter function
															P1	56	NOISE REDUCTION
Input	Set																
	N R P1																
Input	Read																
	N R																
Output	Set																
	N R P1																
Output	Read																
	N R																

MR MEMORY READ

Function	Reads memory.																												Parameter	Format	Parameter function
																													P1	9	SPLIT DATA
																													P2	-	NOT USED
Input	Set																														
	P3 P4 P5 P6 P7 P8 P9																														
Input	Read																														
	M R P1 P3 P4																														
Output	Set																														
	M R P1 P3 P4																														
Output	Read																														
	P5 P6 P7 P8																														

Note: For a vacant channel, the Answer command sends '0' for all parameters except the memory channel number. P1 must be '0' to read the CH 90 - 99 Start frequency and '1' to read the End frequency.

PA PREAMPLIFIER

Function	Sets Preamplifier OFF/ON or reads status.														Parameter	Format	Parameter function
															P1	1	PREAMPLIFIER OFF/ON
Input	Set																
	P A P1																
Input	Read																
	P A																
Output	Set																
	P A P1																
Output	Read																
	P A																

PB PLAY BACK

Function	DRU or CW message playback.														Parameter	Format	Parameter function
															P1	27	PLAYBACK
Input	Set																
	P B P1																
Input	Read																
	P B																
Output	Set																
	P B P1																
Output	Read																
	P B																

PC POWER CONTROL

Function	Sets or reads transmit power.														Parameter P1	Format 47	Parameter function POWER CONTROL	
	Input	Set																
		Read																
Output	Answer																	

RC RIT CLEAR

Function	Sets the RIT frequency shift to 0.														Parameter	Format	Parameter function	
	Input	Set																
		Read																
Output	Answer																	

Note:
This command also clears the XIT frequency (same as RIT shift). The command functions independently from the RIT/XIT control.

PR SPEECH PROCESSOR

Function	Sets Speech Processor OFF/ON or reads status.														Parameter P1	Format 1	Parameter function SPEECH PROCESSOR OFF/ON	
	Input	Set																
		Read																
Output	Answer																	

RD RU RIT DOWN/UP

Function	Lowers/raises RIT frequency.														Parameter	Format	Parameter function	
	Input	Set																
		Read																
Output	Answer																	

Note:
This command also affects the XIT frequency (same as RIT shift). The command functions independently from the RIT/XIT control.

PS POWER SWITCH

Function	Sets Power OFF/ON or reads status.														Parameter P1	Format 1	Parameter function POWER OFF/ON	
	Input	Set																
		Read																
Output	Answer																	

RG RF GAIN

Function	Sets or reads RF gain.														Parameter P1	Format 31	Parameter function RF GAIN	
	Input	Set																
		Read																
Output	Answer																	

PT CW RX PITCH

Function	Sets or reads CW RX pitch.														Parameter P1	Format 52	Parameter function CW RX PITCH	
	Input	Set																
		Read																
Output	Answer																	

RM READ METER

Function	Selects a meter function or reads meter values.														Parameter	Format	Parameter function	
	Input	Set																
		Read																
Output	Answer																	

Parameter P1: 24 METER SWITCH
Parameter P2: 22 METER VALUE

RA RF ATTENUATOR

Function	Sets or reads RF ATT(enuator).														Parameter P1	Format -	Parameter function ATTENUATOR	
	Input	Set																
		Read																
Output	Answer																	

00: OFF
01: DN

RT RIT

Function	Sets RIT OFF/ON or reads status														Parameter P1	Format 1	Parameter function RIT OFF/ON	
	Input	Set																
		Read																
Output	Answer																	

● APPENDIX

RX TX RX, TX

Function	Selects receive/transmit mode.		Parameter	Format	Parameter function
	Input	Set	1 2 3 4 5 6 7 8 9 10 11 12 13 14		
	Input	Read	1 2 3 4 5 6 7 8 9 10 11 12 13 14		
Output	Answer	1 2 3 4 5 6 7 8 9 10 11 12 13 14			

SM S-METER

Function	S-meter reading.		Parameter	Format	Parameter function
			P1	22	S-METER VALUE
Input	Set	1 2 3 4 5 6 7 8 9 10 11 12 13 14			Note: In transmit mode: power meter reading
Input	Read	1 2 3 4 5 6 7 8 9 10 11 12 13 14			
Output	Answer	1 2 3 4 5 6 7 8 9 10 11 12 13 14			

SC SCAN

Function	Sets Scan OFF/ON or reads status.		Parameter	Format	Parameter function
			P1	1	SCAN OFF/ON
Input	Set	1 2 3 4 5 6 7 8 9 10 11 12 13 14			
Input	Read	1 2 3 4 5 6 7 8 9 10 11 12 13 14			
Output	Answer	1 2 3 4 5 6 7 8 9 10 11 12 13 14			

SQ SQUELCH LEVEL

Function	Sets or reads squelch level.		Parameter	Format	Parameter function
			P1	46	SQUELCH LEVEL
Input	Set	1 2 3 4 5 6 7 8 9 10 11 12 13 14			
Input	Read	1 2 3 4 5 6 7 8 9 10 11 12 13 14			
Output	Answer	1 2 3 4 5 6 7 8 9 10 11 12 13 14			

SD SEMI BREAK-IN DELAY TIME

Function	Sets or reads Semi Break-in delay time.		Parameter	Format	Parameter function
			P1	49	SEMI BREAK-IN DELAY TIME
Input	Set	1 2 3 4 5 6 7 8 9 10 11 12 13 14			
Input	Read	1 2 3 4 5 6 7 8 9 10 11 12 13 14			
Output	Answer	1 2 3 4 5 6 7 8 9 10 11 12 13 14			

SR SYSTEM RESET

Function	Resets the transceiver.		Parameter	Format	Parameter function
			P1	50	SYSTEM RESET
Input	Set	1 2 3 4 5 6 7 8 9 10 11 12 13 14			
Input	Read	1 2 3 4 5 6 7 8 9 10 11 12 13 14			
Output	Answer	1 2 3 4 5 6 7 8 9 10 11 12 13 14			

SH DSP SLOPE (HIGH CUT-OFF)

Function	Sets or reads high cut-off frequency.		Parameter	Format	Parameter function
			P1	53	DSP SLOPE (HIGH CUT-OFF)
Input	Set	1 2 3 4 5 6 7 8 9 10 11 12 13 14			
Input	Read	1 2 3 4 5 6 7 8 9 10 11 12 13 14			
Output	Answer	1 2 3 4 5 6 7 8 9 10 11 12 13 14			

TN TONE NUMBER

Function	Sets or reads subtone number (01-39).		Parameter	Format	Parameter function
			P1	14	TONE NUMBER
Input	Set	1 2 3 4 5 6 7 8 9 10 11 12 13 14			Note: Selecting No. 39 (1750 Hz) switches OFF the CTCSS.
Input	Read	1 2 3 4 5 6 7 8 9 10 11 12 13 14			
Output	Answer	1 2 3 4 5 6 7 8 9 10 11 12 13 14			

SL DSP SLOPE (LOW CUT-OFF)

Function	Sets or reads low cut-off frequency.		Parameter	Format	Parameter function
			P1	53	DSP SLOPE (LOW CUT-OFF)
Input	Set	1 2 3 4 5 6 7 8 9 10 11 12 13 14			
Input	Read	1 2 3 4 5 6 7 8 9 10 11 12 13 14			
Output	Answer	1 2 3 4 5 6 7 8 9 10 11 12 13 14			

TO TONE

Function	Sets Subtone OFF/ON or reads status.		Parameter	Format	Parameter function
			P1	1	TONE OFF/ON
Input	Set	1 2 3 4 5 6 7 8 9 10 11 12 13 14			
Input	Read	1 2 3 4 5 6 7 8 9 10 11 12 13 14			
Output	Answer	1 2 3 4 5 6 7 8 9 10 11 12 13 14			

VD VOX DELAY TIME

Function		Parameter		Format	Parameter function
Sets or reads VOX delay time.		P1	51		VOX DELAY TIME
Input	Set	1 2 3 4 5 6 7 8 9 10 11 12 13 14 V D P1 :			
	Read	1 2 3 4 5 6 7 8 9 10 11 12 13 14 V D :			
Output	Answer	1 2 3 4 5 6 7 8 9 10 11 12 13 14 V D P1 :			

VG VOX GAIN

Function		Parameter		Format	Parameter function
Sets or reads VOX gain.		P1	54		VOX GAIN
Input	Set	1 2 3 4 5 6 7 8 9 10 11 12 13 14 V G P1 :			
	Read	1 2 3 4 5 6 7 8 9 10 11 12 13 14 V G :			
Output	Answer	1 2 3 4 5 6 7 8 9 10 11 12 13 14 V G P1 :			

VR VOICE RECALL

Function		Parameter		Format	Parameter function
Triggers the Voice Synthesizer for message output.		P1	55		VOICE RECALL
Input	Set	1 2 3 4 5 6 7 8 9 10 11 12 13 14 V R P1 :			
	Read	1 2 3 4 5 6 7 8 9 10 11 12 13 14 /			
Output	Answer	1 2 3 4 5 6 7 8 9 10 11 12 13 14 /			

VX VOX FUNCTION

Function		Parameter		Format	Parameter function
Sets VOX OFF/ON.		P1	1		VOX OFF/ON
Input	Set	1 2 3 4 5 6 7 8 9 10 11 12 13 14 V X P1 :			
	Read	1 2 3 4 5 6 7 8 9 10 11 12 13 14 V X :			
Output	Answer	1 2 3 4 5 6 7 8 9 10 11 12 13 14 V X P1 :			

XT XIT

Function		Parameter		Format	Parameter function
Sets XIT OFF/ON.		P1	1		XIT OFF/ON
Input	Set	1 2 3 4 5 6 7 8 9 10 11 12 13 14 X T P1 :			
	Read	1 2 3 4 5 6 7 8 9 10 11 12 13 14 X T :			
Output	Answer	1 2 3 4 5 6 7 8 9 10 11 12 13 14 X T P1 :			

INDEX

AGC	30	Step Size	29, 30	Operation	27
AM		Tuning	29	PacTOR	
Transmitting	22	FSK (see RTTY)		Connection (ACC 2)	62
Amplifier, Linear		Full Reset	48	Operation	27
Connection (REMOTE)	61	Fuses, Replacing	2	Partial Reset	48
AMTOR		Gain		Power	
Connection (ACC 2)	62	AF	13	Connecting DC	2
Operation	27	RF	13	Switching ON/OFF	13
Antenna		G-TOR™		Transmit Output	15
Connection	1	Connection (ACC 2)	62	Program Scan	46
Feed Line Loss	1	Operation	27	Programmable	
Antenna Tuner		Headphones Jack (PHONES)	3	Buttons	49
Operation	52	IF Filter		VFO	43
Presetting	52	Bandwidth Change	36	Quick Data Transfer	
Attenuator, RF	37	IF Shift	36	Equipment, Compatible	50
Automatic Gain Control	30	Key Jack (PADDLE/KEY)	3	Equipment, Connection	60
Auto Weighting	34	Keyer, Electronic		Equipment, Needed	50
Bands, Changing	13	Auto Weighting	34	Using	50
Beat Cancel	38	Bug Key Function	35	Reset	
Beep Function	49	Messages, Checking	35	Full	48
Break-in, Full/Semi (see CW)		Messages, Storing	35	Partial	48
Bug Key Function	35	Messages, Transmitting	35	RIT	30
Carrier-operated mode	47	Linear Amplifier		RTTY	
Clover		Connection (REMOTE)	61	Connection (RTTY, ACC 2)	61
Connection (ACC 2)	62	Lock Function	48	Operation	26
Operation	27	Lockout, Memory Channels	44	Satellite Operation	28
Computer Control		LSB (see SSB)		Scan	
Commands	71	Memory Channels		Carrier-operated	47
Communication Parameters	51	Conventional	39	Hold	46
Connection	60	Erasing	43	Lockout	44
Connector (COM)	70	Lockout	44	Memory, All-Channel	47
CW		Quick, Recalling	45	Memory, Group	47
Break-in, Full	34	Quick, Storing	44	Program	46
Break-in, Semi	34	Quick, Transfers to VFO	45	Start/End Frequencies	43
Pitch	21	Recalling	40	Time-operated	47
Reverse	21	Resetting	43	Speaker, External (EXT SP)	3
Sidetone, Frequency	21	Scanning, All-Channel	47	Specifications	68
Sidetone, Volume	21	Scanning, Group	47	Speech Processor	32
Transmitting	21	Scrolling	41	Split-Frequency Operation	23
Zero Beating	21	Start/End Frequencies	43	Squelch	14
Digital Recording Unit (optional)		Storing, Scan Limits	43	SSB, Transmitting	20
Installation	57	Storing, Simplex	39	SSTV	
Message Interval	54	Storing, Split-Frequency	40	Connection (ACC 2)	62
Playback	53	Transfer, To Memory	42	Operation	28
Recording	53	Transfer, To VFOs	42	TF-SET (Transmit Frequency Set)	23
Display Dimmer	49	Tunable	41	Time-operated mode	47
DSP		Memory Scan	47	Transmit Inhibit	33
Beat Cancel	38	Menu		Transverter	51
DSP Filter	37	Access	16	Troubleshooting	65
Noise Reduction	38	Configuration	17	USB (see SSB)	
External Speaker (EXT SP)	3	Cross Reference	19	VFO	
FAX/Facsimile		Description	16	Equalizing A=B	30
Connection (ACC 2)	62	Meter	14	Programmable	43
Operation	28	Microphone		Selecting A/B	13
FM		Compatible	3	Voice Synthesizer (optional)	
Band Plan	24	Connector (MIC)	3	Installation	58
CTCSS	25	Gain	15	Using	55
Repeaters	24	Operation	9	Volume	
Subtone, Frequency	25	Noise		AF Gain	13
Subtone, Type	25	Blanker	36	RF Gain	13
Transmitting	22	Reduction	38	VOX (Voice-Operated Transmit)	
TX Deviation	22	Optional Accessories		Adjusting Delay	31
Frequency		Available	56	Adjusting Microphone	
Fine Tuning	30	Installation	57	Level	31
Keypad Entry	29	Packet		XIT	32
Rounding	29	Connection (ACC 2)	62		

KENWOOD
